

INSTALLATION AND OPERATION MANUAL

KBMK SERIES

Adjustable Frequency Drives

for 1/8 HP thru 1 HP 3-Phase AC Motors Rated 208 – 230 VAC, 50/60 Hz

NEMA-1 / IP-40

Operate from 115* and 208/230 Volt 50/60 Hz AC Line
Variable Speed / Soft-Start with Electronic Motor Overload Protection¹

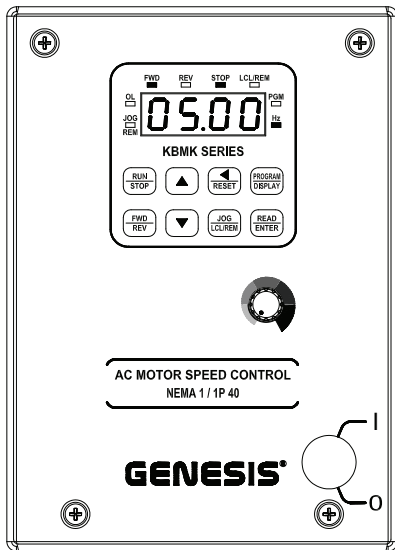

*IMPORTANT

This drive is factory set for:

1. 60 Hz Motors.

For 50 Hz motors, see Figure 12, on page 16.

2. 208/230 Volt AC Line Input.

For 115 Volt AC line input, see Section 7, on page 14.



See Safety Warning, on page 5.



This Manual Covers Models KBMK-24D and KBMK-24DF²

The information contained in this manual is intended to be accurate. However, the manufacturer retains the right to make changes in design which may not be included herein.

Notes: 1. UL approved as an electronic overload protector for motors. 2. Model KBMK-24DF contains a built-in AC line Class A RFI (EMI) filter which meets CE Council Directive 89/336/EEC Industrial Requirement. For Class B Residential Requirement, install the KBRF-300 RFI (EMI) Filter (Part No. 9484).

GENESIS[®]

Automation and Control

COPYRIGHT © 2008 KB Electronics, Inc.
(see back cover)

TABLE OF CONTENTS3

Sections	Page
1 Quick-Start Instructions	4
2 Safety Warning	5
3 Introduction	6
4 Important Application Information	10
5 Mounting Instructions	11
6 Electrical Connections Instructions	11
7 AC Line Input Voltage Selection (Jumper J1)	14
8 Recommended High Voltage Dielectric Withstand Testing (Hi-Pot Testing)	14
9 Drive Operation	15
10 Programmable Function Summary List	21
11 Status LEDs	29
Appendix A – Optional IODA Input/Output Multi-function Board	30
Limited Warranty	Back Cover

Tables	Page
1 Optional Accessories	7
2 Electrical Ratings	7
3 General Performance Specifications	8
4 Drive Terminal Blocks Wire and Tightening Torque Specifications	12
5 Multi-Function Output Relay "Run" and "Fault" Operating Modes	13
6 Keypad Description	16
7 Digital Readout Codes	20
8 LED Descriptions	29
9 IODA Status Indicator LED	31
10 IODA Terminal Block TB1 Wire and Tightening Torque Specifications	31
11 IODA Functions, Features, and Terminal Assignment	32
12 Multi-Function Input Terminal, Function No., and Code Assignment	32
13 Preset Frequency Selection with 2-Wire Start/Stop Programming	33
14 Preset Frequency Selection	34
15 Up/Down Frequency Control Programming	35
16 Accel/Decel 2 Programming	35
17 Forward/Stop-Reverse/Stop Programming	36
18 External Fault Programming	37
19 Reset Programming	38
20 2-Wire Start/Stop Programming	38
21 3-Wire Start/Stop Programming	39
22 Analog Input 1 Electrical Ratings	41
23 Analog Input 1 Signal Voltage Following Programming	42
24 Analog Input 2 Electrical Ratings	43
25 Analog Input 2 Signal Current Following Programming	43
26 Analog Outputs 1 and 2 Electrical Ratings	43
27 Analog Outputs 1 and 2 Programming	44
28 Remote Unidirectional Speed Potentiometer Programming	45
29 Remote Bidirectional Speed Potentiometer Programming	46
30 Remote Speed Potentiometer with Forward/Reverse Programming	47
31 Multi-Function Output Relay Contacts Programming	48
32 Multi-Function Open Collector Outputs Programming	49
33 Multi-Function Open Collector Outputs Electrical Ratings	49

Figures	Page
1 Quick-Start Connection Diagram	4
2 Keypad Layout with Built-In Speed Potentiometer	8
3 Cover Layout	9
4 Drive Layout	9
5 Mechanical Specifications	10
6 Maximum Allowed Motor Torque vs. Speed	11

TABLE OF CONTENTS (CONTINUED)

Figures	Page
7 Open Ventilated Motor with External Fan Cooling	11
8 AC Line Input, Motor, and Ground Connections	12
9 Multi-Function Output Relay Contacts	13
10 AC Line Input Voltage Selection (Jumper J1)	14
11 Typical Hi-Pot Test Setup	15
12 Flow Chart to Program the Drive for 50 Hz Motors	16
13 Flow Chart to Program Motor Current from 3.6 Amps to 2.5 Amps	17
14 Flow Chart to Change Set Frequency from 5.00 Hz to 43.21 Hz	17
15 Flow Chart to Program Accel Time from 1.5 Seconds to 120 Seconds	18
16 Flow Chart to Program the Drive to Display Motor RPM	18
17 Flow Chart to Program the Drive to Display Custom Units "012.0"	19
18 Flow Chart Showing Motor Current, Motor Voltage, and Bus Voltage Added to the Basic Display	19
19 Function No. Description	21
20 IODA Layout	31
21 IODA Terminal Block TB1 Layout	32
22 Preset Frequency Selection with 2-Wire Start/Stop Connections	33
23 Up/Down Frequency Control with 2-Wire Start/Stop Connections	35
24 Accel/Decel 2 Connections	36
25 Forward/Stop-Reverse/Stop Connections	36
26 External Fault Connections	37
27 Reset Connections	38
28 2-Wire Start/Stop Connections	39
29 3-Wire Start/Stop Connections	39
30 Analog Input 1 Signal Gain and Offset with Positive Slope	40
31 Analog Input 1 Signal Gain and Offset with Negative Slope	41
32 Analog Input 1 Signal Voltage Following Connections	42
33 Analog Input 2 Signal Current Following Connections	43
34 Analog Outputs 1 and 2 Gain	44
35 Analog Outputs 1 and 2 Connections	44
36 Remote Unidirectional Speed Potentiometer Connections	46
37 Remote Bidirectional Speed Potentiometer Connections	46
38 Remote Speed Potentiometer with Forward/Reverse Connections	47
39 Multi-Function Output Relays Contact Connections	48
40 Multi-Function Open Collectors Output Connections	49
41 Typical Application for Open Collectors Output	49

Items Included in this Package: KBMK Adjustable Frequency Drive, Installation and Operation Manual, Hardware Bag (containing Trimpot Adjustment Tool, AC Line Input Voltage Selection Jumper, and an extra Feed-Through Bushing), CE Approved Product Information Card, and Warranty Registration Card.

UL NOTICE

230VAC Drives

Suitable for use on a circuit capable of delivering not more than 5 kA RMS symmetrical amperes,
230 Volts maximum.

Use copper conductors rated 75 °C.

Suitable for operation in a maximum surrounding air temperature of 40 °C.

IMPORTANT APPLICATION INFORMATION

- 50 Hz Motors:** This drive has been factory programmed to operate 60 Hz motors. For 50 Hz motor operation, set Function No. 0.00 to 50 Hz "0001". See Figure 12, on page 16.
- Motor Current Setting:** The motor current is factory set to 3.6 Amps (1 HP (0.75 kW)), as shown in Table 2, on page 7. In order for the motor overload protection to operate properly, the drive must be reprogrammed to the actual motor nameplate current. Use Function No. 0.01 to enter the motor nameplate current. See Figure 13, on page 17.

1 QUICK-START INSTRUCTIONS

Important: You must read these simplified instructions before proceeding. These instructions are to be used as a reference only and are not intended to replace the details provided herein. You must read the Safety Warning, on page 5, before proceeding.

Note: This drive contains bus capacitors, which must be reconditioned if the drive has been in storage for over 1 year. To recondition the bus capacitors, apply the AC line, with the drive in the Stop Mode, for a minimum of 30 minutes.

See Figure 1. Also see Section 4 - Important Application Information, on page 10.



WARNING! HIGH VOLTAGE – Disconnect main power before making connections to the drive. Do not depend on the green Power On LED (ON), located on the drive's PC board, as shown in Figure 4, on page 9, or the Status LEDs and the 4-Digit Display, located on the front cover, to no longer be illuminated as a guaranteed power off condition.

Note: It is recommended that both Feed-Through Bushings be used to connect the drive. If signal wiring (for the Multi-Function Output Relay contacts or for a Remote Speed Potentiometer) is required, it is recommended that the extra Feed-Through Bushing (supplied) be used to replace the center Hole Plug. Standard ½" fittings (not supplied) can also be used in lieu of the Feed-Through Bushings.

FIGURE 1
QUICK-START CONNECTION DIAGRAM¹

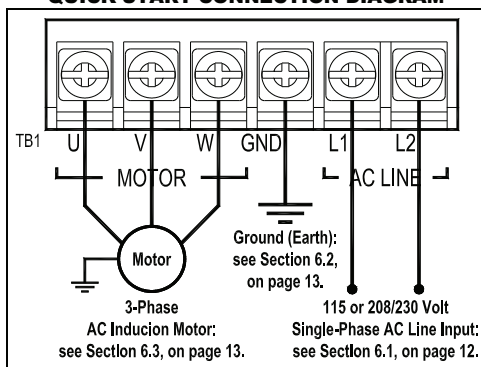

1.1 MOUNTING INSTRUCTIONS: See Section 5, on page 11.

1.2 AC LINE INPUT CONNECTION: Connect the AC line input to Terminal Block TB1 (Terminals "L1", "L2"), as shown in Figure 1, above. Also see Section 6.1, on page 12.

Application Note: If operation with a Ground-Fault Circuit-Interrupter (GFCI) is required, see Function No. 0.04, on page 22.

Note: The drive is factory set for 208/230 Volt AC line input (Jumper J1 not installed). For 115 Volt AC line input, install Jumper J1 (supplied). See Section 7, on page 14.

1.3 AC LINE FUSING: It is recommended that a fuse(s) or circuit breaker(s) be installed in the AC line. Fuse each conductor that is not at ground potential. For the recommended fuse size, see Table 2, on page 7. Also see Section 6.1, on page 12.

- 1.4 GROUND CONNECTION:** Connect the ground wire (earth) to Terminal Block TB1 (Terminal "GND"), as shown in Figure 1, on page 4.
- 1.5 MOTOR CONNECTION:** Connect the motor to Terminal Block TB1 (Terminals "U", "V", "W"), as shown in Figure 1, on page 4. Be sure the motor is properly grounded. Motor cable length should not exceed 100ft (30 m) – special reactors may be required – consult our Sales Department. See Section 6.3, on page 13.
- 1.6 60 Hz AND 50 Hz MOTR OPERATION:** The drive is factory set for 60 Hz motors (Function No. 0.00 set to "0000"). For 50 Hz motors, set Function No. 0.00 to "0001", as shown in Figure 12, on page 16. For other motor frequencies, set Function No. 0.00 to "0002".
- 1.7 JUMPER J1 SETTING:** The drive is factory set for 208/230 Volt AC line input (Jumper J1 not installed). For 115 Volt AC line input, install Jumper J1 (supplied). See Section 7, on page 14.
- 1.8 MOTOR OVERLOAD PROTECTION:** Function No. 0.01 must be set to the motor nameplate current for proper operation of the I²t Motor Overload Protection. See Figure 13, on page 17.

2 SAFETY WARNING

Definition of Safety Warning Symbols



Electrical Hazard Warning Symbol: Failure to observe this warning could result in electrical shock or electrocution.



Operational Hazard Warning Symbol: Failure to observe this warning could result in serious injury or death.



This product should be installed and serviced by a qualified technician, electrician, or electrical maintenance person familiar with its operation and the hazards involved. Proper installation, which includes electrical connections, fusing or other current protection, and grounding, can reduce the chance of electrical shocks, and/or fires, in this product or products used with this product, such as electric motors, switches, coils, solenoids, and/or relays. Do not use this drive in an explosion-proof application. Eye protection must be worn and insulated adjustment tools must be used when working with drive under power. This product is constructed of materials (plastics, metals, carbon, silicon, etc.) which may be a potential hazard. Proper shielding, grounding, and filtering of this product can reduce the emission of radio frequency interference (RFI) which may adversely affect sensitive electronic equipment. It is the responsibility of the equipment manufacturer and individual installer to supply this Safety Warning to the ultimate end user of this product. (SW 1/2006)

The drive contains electronic Start/Stop circuits, which can be used to start and stop the drive. However, these circuits are never to be used as safety disconnects since they are not fail-safe. Use only the AC line for this purpose.

Be sure to read and follow all instructions carefully. Fire and/or electrocution can result due to improper use of this product.



This product complies with all CE directives pertinent at the time of manufacture. Contact our Sales Department for Declaration of Conformity. Installation of a CE approved RFI filter is required. See RFI Filters & Chokes Selection Guide D-321 (Part No. A42027) for the selection of filters to meet the Industrial or Residential Standard. Additional shielded cable and/or AC line cables may be required along with a signal isolator (IODA Input/Output Multi-Function Board (Part No. 9668)).

3 INTRODUCTION

Thank you for purchasing the KBMK Adjustable Frequency Drive. KB Electronics, Inc. is committed to providing total customer satisfaction by producing quality products that are easy to install and operate.

The KBMK Adjustable Frequency Drives are variable speed controls housed in a rugged NEMA-1 / IP-40 enclosure. They are designed to operate 208 – 230 Volt 50 & 60 Hz 3-phase AC induction motors from 1/8 HP thru 1 HP. The sine wave coded Pulse Width Modulated (PWM) output provides high motor efficiency and low noise. Adjustable Linear Acceleration and Deceleration make the drive suitable for soft-start applications. Model KBMK-24DF contains a built-in AC line Class A RFI (EMI) filter which meets the CE Council Directive 89/336/EEC Industrial Requirement.

Due to its user-friendly design, the KBMK is easy to install and operate. Setting the drive to specific applications is accomplished using the Multi-Function Keypad, which provides easy operation and programming of the drive. To facilitate programming, all similar functions are presented in common groups.

The 4-Digit LED Display provides readout of drive operating parameters and programming functions and displays Output Frequency, Motor RPM, Output Current, Output Voltage, Bus Voltage, Function Codes and Values, Fault Codes, and Custom Units. In addition to operating the drive, the Multi-Function Keypad is used to change drive operating parameters, reprogram functions, and change the display output. The LEDs provide indication of the drive's status and operating mode (Hz, PGM, LCL/REM, STOP, FWD, REV, OL, JOG/REM).

The optional IODA Input/Output Multi-Function Board provides a variety of functions, which include preset frequency, up/down frequency control, signal isolation, isolated output voltage for controlling auxiliary devices, open collector outputs, and output relay contacts. See Appendix A, on pages 30 – 49. See Function Groups 0 – 10, on pages 22 – 28.

Main Features: Adjustable RMS Current Limit and I²t Motor Overload Protection.* Flux Vector Compensation with Static Auto-Tune and Boost provides high torque and excellent load regulation over a wide speed range. Power Start™ delivers over 200% motor torque to ensure startup of high frictional loads. Programmable Injection Braking provides rapid motor stop. Electronic Inrush Current Limit (EICL™) eliminates harmful AC line inrush current, which allows the drive to be line switched. A Multi-Function Output Relay is provided, which can be used to turn on or off equipment or to signal a warning if the drive is put into various modes of operation. The drive is suitable for machine or variable torque (HVAC) applications.

Standard Front Panel Features: 4-Digit LED Display, Multi-Function Keypad, Status Indicator LEDs, and a Built-In Speed Potentiometer.

Optional Accessories: Optional accessories include an On/Off AC Line Switch and IODA Input/Output Multi-Function Board. See Table 1, on page 7.

**UL approved as an electronic overload protector for motors.*

3.1 STANDARD FEATURES

- **Multi-Function Keypad:** The keys are used to operate the drive, change operating parameters, reprogram functions, and change the display output (Run/Stop, Forward/Reverse, Up, Down, Shift/Reset, Jog-Local/Remote, Program/Display, Read/Enter).
- **4-Digit LED Display:** Provides readout of drive operating parameters and programming functions. Displays Output Frequency, Motor RPM, Output Current, Output Voltage, Bus Voltage, Function Codes and Values, Fault Codes, and Custom Units.
- **LED Status Indicators:** The LEDs provide indication of the drive's status and operating mode (Hz, PGM, LCL/REM, STOP, FWD, REV, OL, JOG/REM).
- **Multi-Function Output Relay Contacts:** Can be used to turn on or off equipment or to signal a warning if the drive is put into various modes of operation. (The optional IODA Input/Output Multi-Function Board contains 9 digital and analog inputs, 4 digital and analog outputs, and 2 additional relay outputs.)
- **Motor Current Selection:** Programmable motor current allows the drive to be used on a wide range of motor horsepower.
- **Compatible with most GFCIs.** See Function No. 0.04, on page 22.

3.2 PERFORMANCE FEATURES

- **Power Start™** – Provides more than 200% starting torque which ensures startup of high frictional loads.
- **Programmable Flux Vector Compensation with Static Auto-Tune and Boost** – Provides excellent load regulation and dynamic response over a wide speed range.
- **Speed Range – 60:1**

3.3 PROTECTION FEATURES

- **Motor Overload (I²t) with RMS Current Limit:** Provides motor overload protection, which prevents motor burnout and eliminates nuisance trips.*
- **Electronic Inrush Current Limit (EICL™):** Eliminates harmful inrush AC line current during startup.
- **Short Circuit:** Shuts down the drive if a short circuit occurs at the motor (phase-to-phase).
- **Decel Extend:** Eliminates tripping due to bus overvoltage caused by rapid deceleration of high inertial loads.
- **Undervoltage and Overvoltage:** Shuts down the drive if the AC line input voltage goes below or above the operating range.
- **MOV Input Transient Suppression.**
- **Microcontroller Self Monitoring and Auto-Reboot.**

*UL approved as an electronic overload protector for motors (UL File E188974).

3.4 PROTECTION FEATURES

- **AC LINE INPUT VOLTAGE SELECTION:** (115/230 Volts AC) (J1)

**TABLE 1
OPTIONAL ACCESSORIES**

Description	Part No.
On/Off AC Line Switch: Panel mounted. Used to turn the power on and off to the drive.	9683
IODA Input/Output Multi-Function Board: Provides a variety of functions, which include preset frequency, Up/Down Frequency, signal isolation, isolated output voltage for auxiliary devices, open collector outputs, and output relay contacts. Mounts on the drive's PC board with three screws (provided). All of the IODA inputs and outputs are isolated from the AC line.	9668

**TABLE 2
ELECTRICAL RATINGS**

Model	Part No.	AC Line Input			Fuse or Circuit Breaker Rating (Amps)	Output			Net Weight	
		Volts AC (50/60 Hz)	Phase (Φ)	Maximum Current (Amps AC)		Voltage Range (Volts AC)	Maximum Continuous Load Current (RMS Amps/Phase)	Maximum Horsepower (HP (kW))	Lbs.	kg
KBMK-24D	9680	115	1	16	20	0 – 230	3.6	1 (.75)	2.26	1.03
		208/230 ¹	1	10	15					
KBMK-24DF ²	9681	115	1	16	20	0 – 230	3.6	1 (.75)	2.33	1.06
		208/230 ¹	1	10	15					

Notes: 1. The drive is factory set for 208/230 Volt AC line input (J1 not installed). For 115 volt AC line input, install Jumper J1 (supplied). See Figure 10, on page 14. 2. Model KBMK-24DF contains a built-in AC line Class A RFI (EMI) filter which meets the CE Council Directive 89/336/EEC Industrial Requirement.

**TABLE 3
GENERAL PERFORMANCE SAPECIFICATIONS**

Description	Specification
115 Volt AC Line Input Voltage Operating Range (Volts AC)	115 (±15%)
208/230 Volt AC Line Input Voltage Operating Range (Volts AC)	208 (-15%) / 230 (+15%) ¹
Maximum Load (% Current Overload for 1 Minute)	150
Switching Frequency (kHz) ²	8, 10, 12
Output Frequency Resolution (Bits, Hz)	10, .06
Minimum Operating Frequency at Motor (Hz)	0.3
Speed Range (Ratio)	60:1
Speed Regulation (30:1 Speed Range, 0 – Full Load) (% Base Speed) ³	2.5
Overload Protector Trip Time for Stalled Motor (Seconds)	6
Multi-Function Output Relay Contact Rating (Amps at 30 Volts DC, 125 Volts AC, 250 Volts AC)	1, 0.5, 0.25
Undervoltage/Overvoltage Trip Points for 115 Volt AC Line Input (± 5%) (Volts AC) ⁴	76 / 141
Undervoltage/Overvoltage Trip Points for 208/230 Volt AC Line Input (± 5%) (Volts AC) ⁴	151 / 282
Operating Temperature Range (°C / °F)	0 – 45 / 32 – 113
Operating Humidity Range (% Relative, Non-condensing)	0 – 95
Storage Temperature (°C / °F)	-25 – +85 / -13 – +185

Notes: 1. The drive is factory set for 208/230 Volt AC line input (J1 not installed). For 115 volt AC line input, install Jumper J1 (supplied). See Figure 10, on page 14. 2. Set by Function No. 3.15. 3. Dependent on motor performance. 4. Do not operate the drive outside the specified AC line input voltage operating range.

**FIGURE 2
KEYPAD LAYOUT WITH BUILT-IN SPEED POTENTIOMETER**

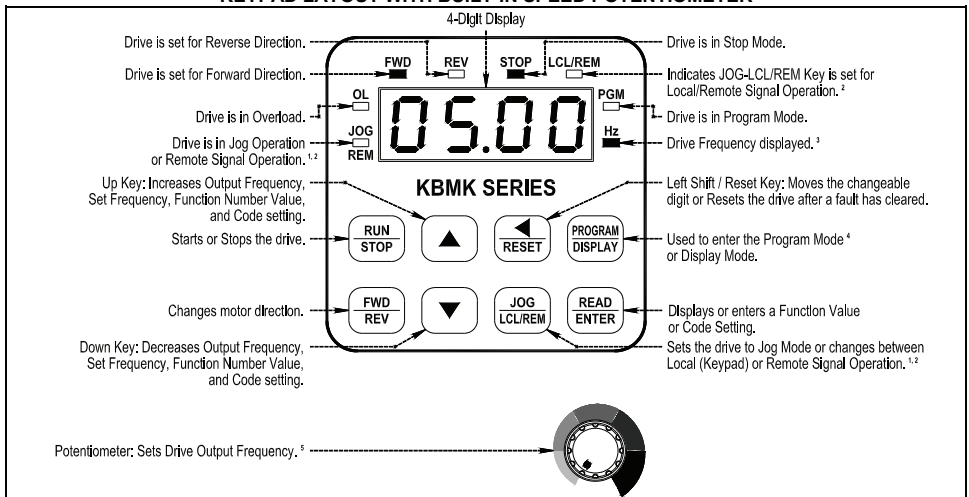

Notes: 1. The JOG-LCL/REM Key is factory programmed to function as a Jog Key. When the JOG-LCL/REM Key is pressed, the "JOG/REM" LED will illuminate and the display will show the Jog Frequency Setting (see Function No. 3.13, on page 24). 2. If the JOG-LCL/REM Key is reprogrammed for Local (Keypad) and Remote Signal Operation (see Function No. 2.02, on page 24), the "LCL/REM" LED will illuminate. Pressing the JOG-LCL/REM Key will toggle between Local (Keypad) and Remote Signal Operation. When Remote Signal Operation is selected, the "JOG/REM" LED will flash. The optional IODA (Part No. 9668) is required for remote signal operation. 3. The "Hz" LED will illuminate when the display is set to show Output Frequency. 4. If the PROGRAM/DISPLAY Key is pressed while Set Frequency is displayed, the previously entered Function Number will be shown. If the PROGRAM/DISPLAY Key is pressed while Function Number is displayed, the Set Frequency will be shown. When more than one display function is enabled, the PROGRAM/DISPLAY Key is used to toggle between displays, as shown in Figure 18, on page 19. 5. To change the Keypad for Potentiometer Operation, set Function No. 2.00 to "0001".

**FIGURE 3
COVER LAYOUT**

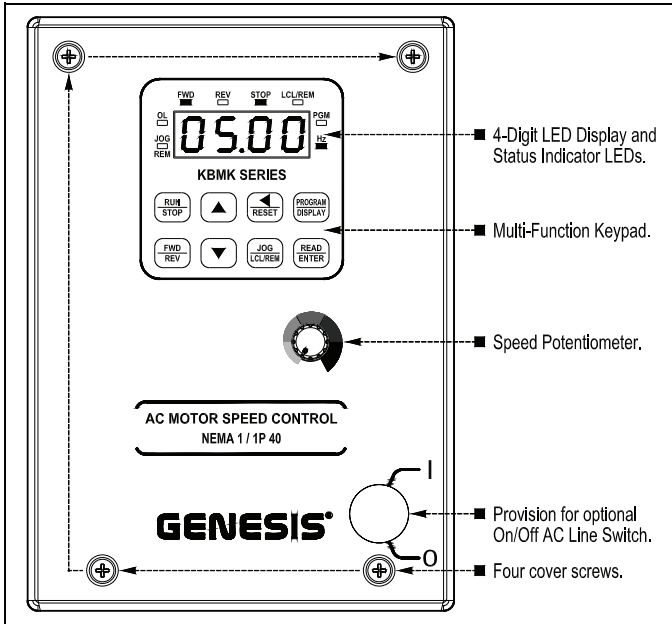

**FIGURE 4
DRIVE LAYOUT**

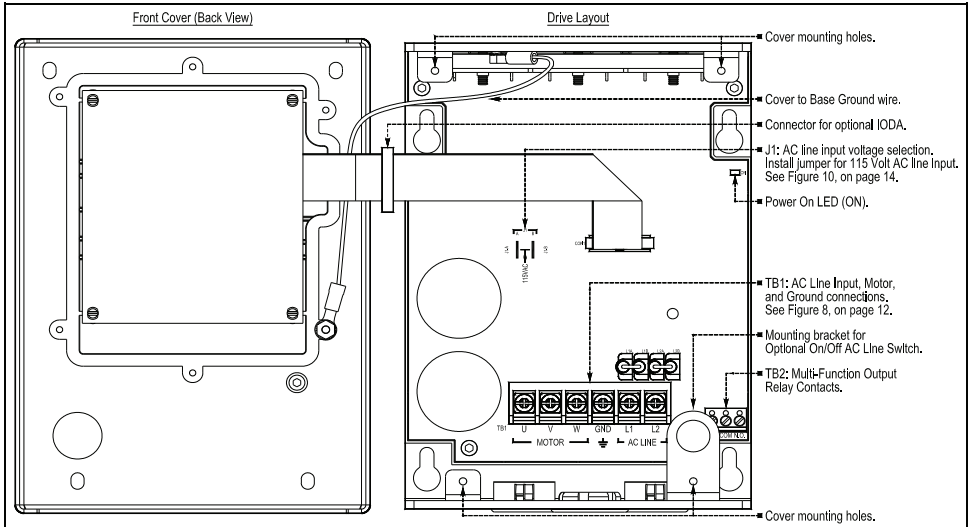
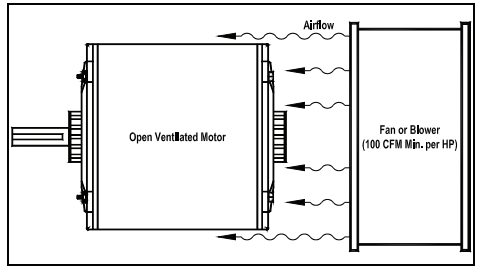
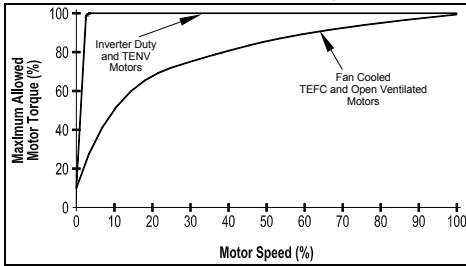

FIGURE 7**OPEN VENTILATED MOTOR WITH EXTERNAL FAN COOLING****FIGURE 6****MAXIMUM ALLOWED MOTOR TORQUE VS. SPEED**

- 4.2 ELECTRONIC MOTOR OVERLOAD PROTECTION:** The drive contains Modified I^2t Overload Protection.* Part of this function consists of a Current Limit (CL) circuit, which limits the drive current to a preset level of 160% of the Motor Nameplate Rated Current setting. The factory setting for motor nameplate current is the drive rated current, which must be set to the actual motor nameplate current (see Important Application Information (Item 2), on page 3). See Table 2, on page 7. Also see Function No. 0.01, on page 22.

Standard I^2t is undesirable because it causes nuisance tripping. It allows a very high motor current to develop and will turn the drive off after a short period of time. KB's RMS Current Limit Circuit avoids this nuisance tripping while providing maximum motor protection.

If the motor is overloaded to 120% of the Motor Nameplate Rated Current setting, the I^2t Timer starts. If the motor continues to be overloaded at the 120% level, the timer will shut down the drive after 30 minutes. If the motor is overloaded to 160% of full load, the drive will trip in 6 seconds.

*UL approved as an overload protector for motors.

5 MOUNTING INSTRUCTIONS

It is recommended that the drive be mounted vertically on a flat surface with adequate ventilation. Leave enough room below the drive to allow for AC line, motor connections, and any other wiring that is required. Care should be taken to avoid extreme hazardous locations where physical damage can occur. When mounting the drive in an enclosure, the enclosure should be large enough to allow for proper heat dissipation so that the ambient temperature does not exceed 45°C (113 °F) at full rating. See Figure 5, on page 10.



WARNING! Do not use this drive in an explosion-proof application.
Be sure the drive is securely mounted.

6 ELECTRICAL CONNECTIONS

See Table 4, for terminal block wire and tightening torque specifications.



WARNING! HIGH VOLTAGE – Read Safety Warning, on page 5, before using the drive. Disconnect main power before making connections to the drive. To avoid electric shock, be sure to properly ground the drive.

Application Note: To avoid erratic operation, do not bundle the AC line and motor wires with each other or with wires from signal following, start/stop contacts, or any other signal wires. Also, do not bundle motor wires from multiple drives in the same conduit. Use shielded cables on all signal wiring over 12" (30 cm). The shield should be earth grounded on the drive side only. Connect the drive in accordance with the National Electrical Code requirements and other local codes that may apply.

Be sure to properly fuse each AC line conductor that is not at ground potential. Do not fuse neutral or grounded conductors. A separate AC line switch or contactor must be connected as a disconnect so that each ungrounded conductor is opened. For fuse or circuit breaker selection, see Table 2, on page 7. Also see Section 6.1, on page 12.

The drive is designed with a removable cover. To open the cover, the two front cover screws must be removed. After mounting the drive and making all connections, install and tighten the four front cover screws to 5 in-lbs (6 kg-cm). Do not over tighten.

TABLE 4
DRIVE TERMINAL BLOCKS WIRE AND TIGHTENING TORQUE SPECIFICATIONS

Terminal Block	Description	Maximum Wire Size (Cu)		Recommended Tightening Torque	
		AWG	mm ²	in-lbs	kg-cm
TB1	AC Line Input and Motor Wiring	12	3.3	7	8
TB2	Multi-Function Output Relay Contacts	16	1.3	3.5	4

6.1 AC LINE INPUT CONNECTION (See Warning, on page 11): Connect the AC line input to Terminal Block TB1 (Terminals "L1", "L2"), as shown in Figure 8. See Table 2, on page 7.

Application Note: If operation with a Ground-Fault Circuit-Interrupter (GFCI) is required, see Function No. 0.04, on page 22.

Note: The drive is factory set for 208/230 Volt AC line input (Jumper J1 not installed). For 115 Volt AC line input, install Jumper J1 (supplied). See Section 7, on page 14.

AC Line Fusing: The drive does not contain line fuses. Most electrical codes require that each ungrounded conductor contain circuit protection. **Do not fuse neutral or ground connections.** It is recommended to install a fuse (Littelfuse 326, Buss ABC, or equivalent) or a circuit breaker (Square D QOU or equivalent) in series with each ungrounded conductor. **Do not fuse motor leads.** For the recommended fuse size, see Table 2, on page 7.

Connect the drive in accordance with the National Electrical Code requirements and other local codes that may apply to the application.

FIGURE 8
AC LINE INPUT, MOTOR, AND GROUND CONNECTIONS

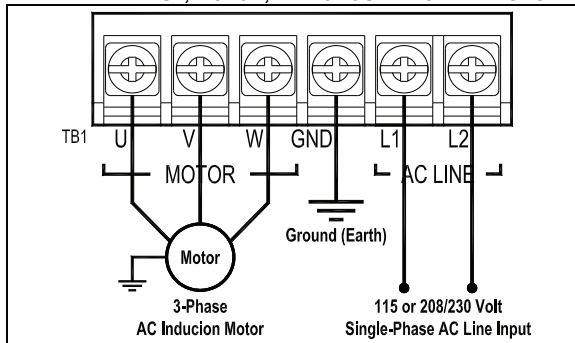

- 6.2 GROUND CONNECTION:** Connect the ground (earth) wires from the AC line and motor to Terminal Block TB1 (Terminal "GND"). Be sure the motor is also properly grounded. See Figure 8, on page 12.
- 6.3 MOTOR CONNECTION:** Connect the motor to Terminal Block TB1 (Terminals "U", "V", "W"). See Figure 8, on page 12. Be sure the motor is properly grounded. Motor cable length should not exceed 100 ft (30 m) – special reactors may be required – consult our Sales Department. Be sure Function No. 0.01 is set to the corresponding Motor Nameplate Current.

Note: If the motor does not rotate in the desired direction, either: 1. Reverse any two motor leads (with AC line disconnected and motor stopped). or 2. Use the FWD/REV Key. or 3. Use Function No. 1.02 to reprogram the forward and reverse direction.

- 6.4 MULTI-FUNCTION OUTPUT RELAY CONNECTIONS:** The Multi-Function Output Relay Contacts are located at TB2, as shown in Figure 9. The Multi-Function Output Relay is factory programmed to function as a "Run" relay (Function No. 5.00 set to "0000"). When the drive is put into the Run Mode, the relay contacts will change state (the Normally Open (N.O.) contact will close and the Normally Closed (N.C.) contact will open). See Table 5.

When the Multi-Function Output Relay is programmed to function as a "Fault" relay (Function No. 5.00 set to "0001") and a fault occurs while the drive is in the Run Mode, the relay contacts will change state. The Normally Open (N.O.) contact (closed in the Run Mode) will open and the Normally Closed (N.C.) contact (open in the Run Mode) will close. See Table 5.

The Multi-Function Output Relay can also be programmed for the following functions, as shown in the Programmable Function Summary List (Section 10, Function Group 5, on page 21): Target Frequency, Frequency Threshold, I²t or I-t Fault Mode, and Load Loss.

Relay Contact Ratings: 1 Amp at 30 Volts DC, 0.5 Amps at 125 Volts AC, and 0.25 Amps at 250 Volts AC.

**FIGURE 9
MULTI-FUNCTION
OUTPUT RELAY
CONTACTS**

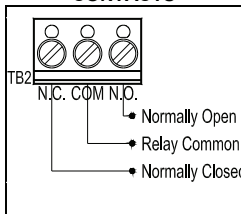

**TABLE 5
MULTI-FUNCTION OUTPUT RELAY "RUN" & "FAULT" OPERATING MODES**

Drive Operating Condition	Function No. 5.00 Set to "0000"		Function No. 5.00 Set to "0001"	
	"Run" Relay Mode		"Fault" Relay Mode	
	N.O. Contact	N.C. Contact	N.O. Contact	N.C. Contact
Power Off	Open	Closed	Open	Closed
Power On (Stop Mode)	Open	Closed	Closed	Open
Run Mode	Closed	Open	Closed	Open
All Faults	Open	Closed	Open	Closed

- 6.5 REMOTE OPERATIONS WHICH REQUIRE THE OPTIONAL IODA (PART NO. 9668):** See Appendix A, on pages 30 – 49. Multi-Function Input Terminals (Preset Frequency Operation, Up/Down Frequency Command, Accel/Decel 2, Forward/Stop-Reverse/Stop Command, External Fault, Reset, 2-Wire and 3-Wire Start/Stop), Signal Following, Analog Signal Output (for controlling auxiliary devices), Remote Speed Potentiometer (5 kΩ), Multi-Function Output Relays, and Multi-function Open Collector Outputs.

7 AC LINE INPUT VOLTAGE SELECTION (JUMPER J1)



Do not connect the AC line input until Jumper J1 is set for the proper input voltage being applied to the drive. Catastrophic failure will occur if a 230 Volt AC line is applied when the drive is set for 115 Volt AC line input.

The drive is factory set for 208/230 Volt AC line input (Jumper J1 not installed). For 115 Volt AC line input, install Jumper J1 (supplied). See Figure 10.

FIGURE 10
AC LINE INPUT VOLTAGE SELECTION¹

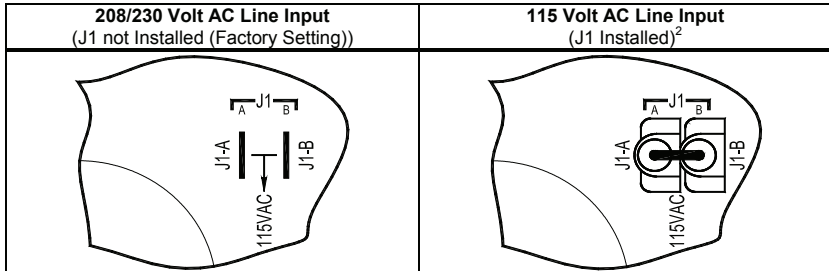

Notes: 1. The drive is factory set for 208/230 Volt AC line input (Jumper J1 not installed). For 115 Volt AC line input, install Jumper J1 (supplied). 2. Jumper J1 is supplied in the hardware bag.

8 RECOMMENDED HIGH VOLTAGE DIELECTRIC WITHSTAND TESTING (HI-POT TESTING)

Testing agencies such as UL, CSA, VDE, etc., usually require that equipment undergo a hi-pot test. In order to prevent catastrophic damage to the drive which has been installed in the equipment, the following procedure is recommended. A typical hi-pot test setup is shown in Figure 11, on page 15. **All drives have been factory hi-pot tested in accordance with UL requirements.**



WARNING! All equipment AC line inputs must be disconnected from the AC power.

CAUTION! Model KBMK-24DF: To prevent catastrophic damage to the drive, perform a DC Hi-Pot test only.

- 8.1 Connect all equipment AC power input lines together and connect them to the H.V. lead of the hi-pot tester. Connect the RETURN lead of the hi-pot tester to the frame on which the drive and other auxiliary equipment are mounted.
- 8.2 The hi-pot tester must have an automatic ramp-up to the test voltage and an automatic ramp-down to zero voltage.

Note: If the hi-pot tester does not have automatic ramping, then the hi-pot output must be manually increased to the test voltage and then manually reduced to zero. This procedure must be followed for each machine to be tested. A suggested hi-pot tester is Slaughter Model 2550.

CAUTION! Instantly applying the hi-pot voltage will cause irreversible damage to the drive, which will void the warranty.

FIGURE 11
TYPICAL HI-POT TEST SETUP

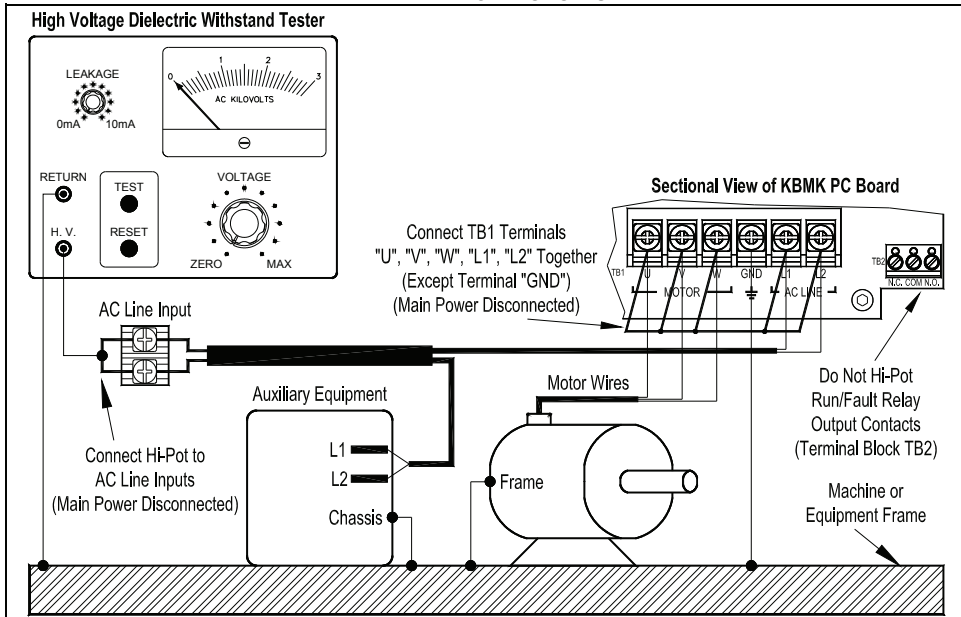

9 DRIVE OPERATION

Before operating the drive, read Section 9.2, for instructions on the Digital Keypad Operation. See Figure 2, on page 8, for the keypad layout.

The 4-digit display can indicate various functions of the drive: Set Frequency, Motor RPM, Output Current and Voltage, Custom Units, Function Numbers, Function Codes or Values, and Fault Codes. See Section 9.4, on page 20.

See Section 9.3, on pages 16 – 19, for information on programming the drive. If an error message appears while programming the drive, see Section 9.5, on page 21.

9.1 START-UP PROCEDURE: After the drive has been properly setup and all connections completed, the start-up procedure can begin. If the AC power has been properly brought to the drive, the LEDs on the front cover will indicate the drive's status, as described in Section 11, on page 29. See Section 9.4, on page 20, for the Digital Readout Codes.

To start the drive, press the RUN Key. The motor will begin to accelerate to the Set Frequency. The factory set frequency is 05.00 Hz.

9.2 KEYPAD DESCRIPTION: The Keypad has eight (8) keys, which are used to program drive functions, as described in Table 6. The eight (8) LEDs provide indication of the drive's operational status, as described in Section 11, on page 24. A Built-In Speed Potentiometer is also provided to set the Drive Frequency (Function No. 2.00 set to "0001"). See Figure 2, on page 8.

Note: To avoid damage, never operate the keypad with a screwdriver or other sharp-ended tool.

**TABLE 6
KEYPAD DESCRIPTION**

Key	Description
	Starts or Stops the drive.
	Changes motor direction.
	Up Key: Increases Output Frequency, Set Frequency, Function Number Value, and Code setting.
	Down Key: Decreases Output Frequency, Set Frequency, Function Number Value, and Code setting.
	Factory programmed to function as a Jog Key. When the key is pressed, it toggles between Run Mode and Jog Mode (the "JOG/REM" LED will illuminate and the display will show the Jog Frequency Setting (see Function No. 3.13)). If the key is reprogrammed for Local/Remote Operation (see Function No. 2.02), the key is used to toggle between Local (Keypad) or Remote Signal Operation (the "LCL/REM" LED will illuminate).* <i>*Optional IODA or Modbus is required for Local/Remote Operation.</i>
	Used to enter Program Mode and Display Mode. If the key is pressed while Set Frequency is displayed, the previously entered Function Number will be shown. If the key is pressed while Function Number is displayed, the Set Frequency will be shown. When more than one display function is enabled, the key is used to toggle between displays. See Figure 18, on page 19.
	Left Shift / Reset Key: Moves the changeable digit or Resets the drive to clear a fault.
	Reads or Enters a Function Number's Value or Code setting. The key is also used to read or enter the frequency setting.

9.3 FLOW CHARTS FOR IMPORTANT PROGRAMMING FUNCTIONS: See Figures 12 – 18, on pages 16 – 19, for flow charts to program important functions. The flow charts also serve as a guide to understand the programming procedure.

Note: See Table 7, on page 20, for a description of the Digital Readout Codes.

**FIGURE 12
FLOW CHART TO PROGRAM THE DRIVE FOR 50 Hz MOTORS**

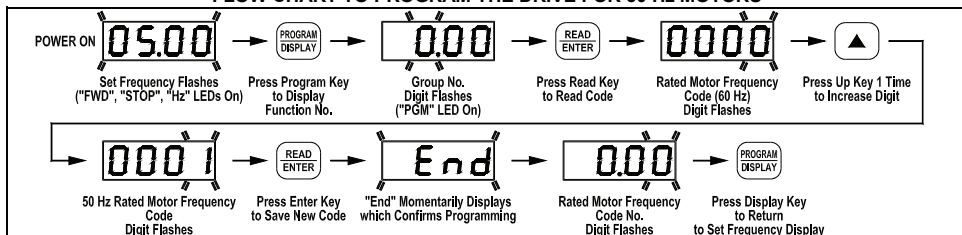
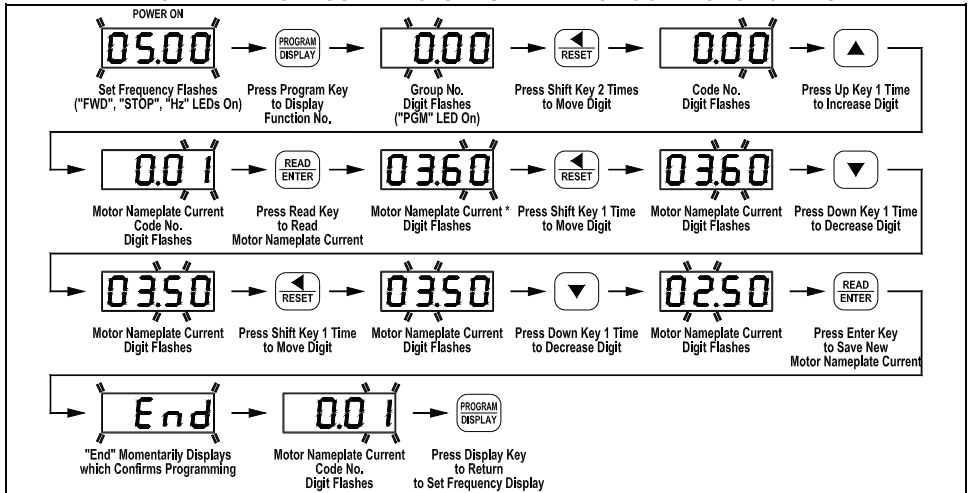
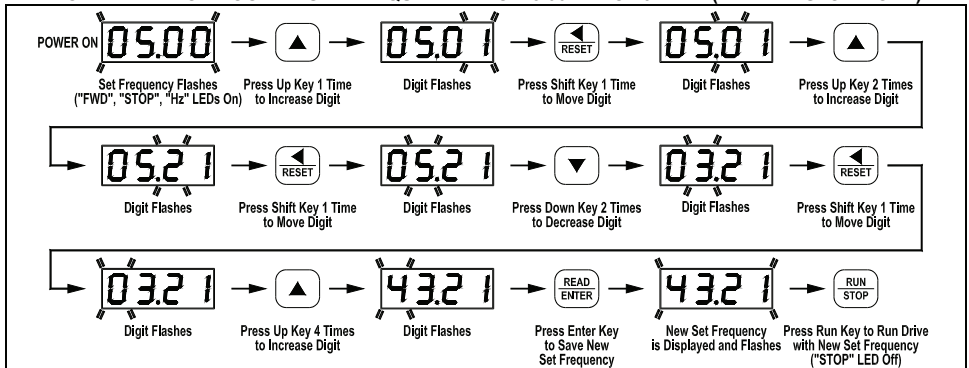

FIGURE 13
FLOW CHART TO PROGRAM MOTOR CURRENT FROM 3.6 AMPS TO 2.5 AMPS



*The drive's factory setting of Motor Nameplate Current (Function No. 0.01) is 3.6 Amps.

FIGURE 14
FLOW CHART TO PROGRAM SET FREQUENCY FROM 5.00 Hz TO 43.21 Hz (DRIVE IN STOP MODE) *



*If Function No. 2.01 is set to "0000", frequency change requires "ENTER". Throughout this sequence you must proceed to the next step within 20 seconds, before the "Press Enter Key" step, or the display will revert to "05.00". The new value will be stored in Function No. 3.00.

FIGURE 15
FLOW CHART TO PROGRAM ACCEL TIME VALUE FROM 1.5 SECONDS TO 120 SECONDS

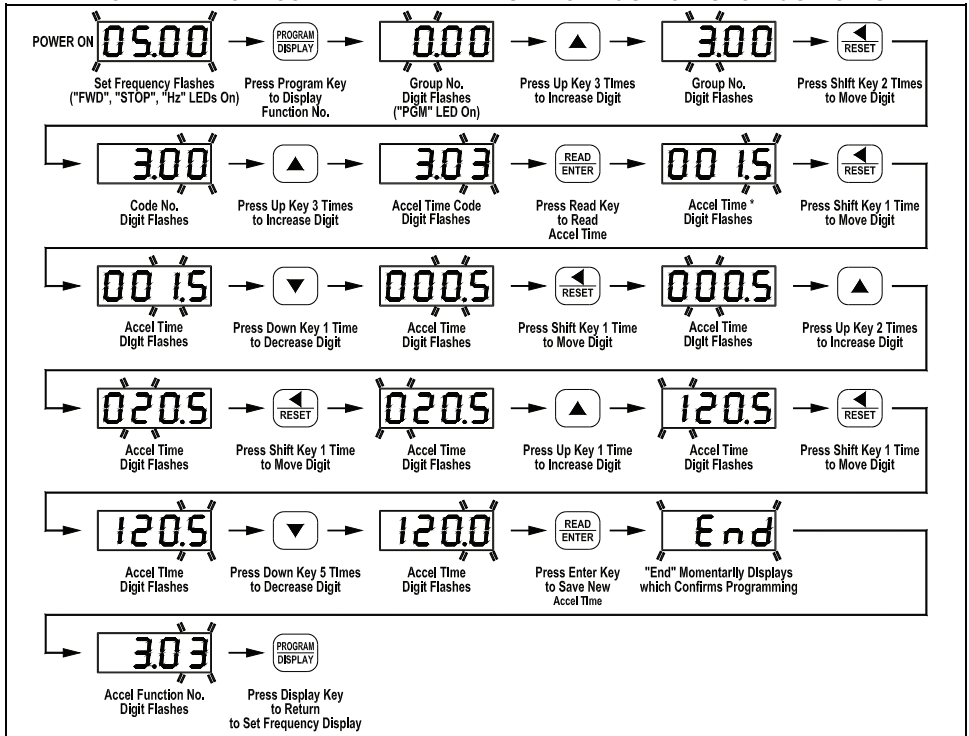

**The factory setting of Accel Time (Function No. 3.03) is "1.5" seconds. The minimum setting of Accel is 0.1 seconds, therefore, the left digits must be changed first since an Accel setting of 000.0 is not allowed.*

FIGURE 16
FLOW CHART TO PROGRAM THE DRIVE TO DISPLAY MOTOR RPM

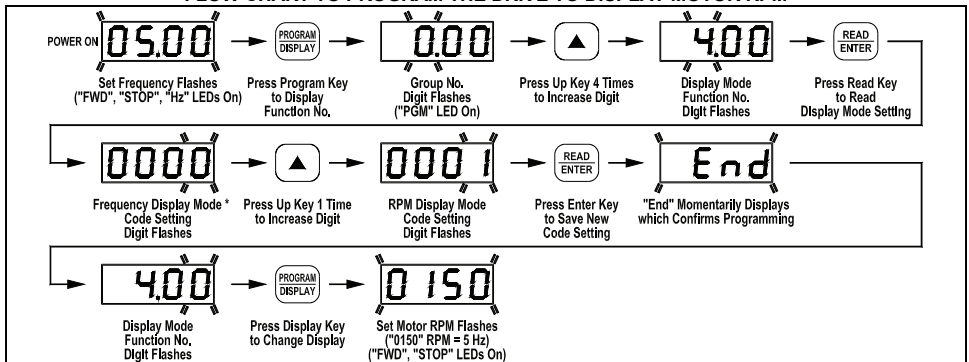

**The factory setting of Display Mode (Function No. 4.00) is Frequency ("0000").*

FIGURE 17
FLOW CHART TO PROGRAM THE DRIVE TO DISPLAY CUSTOM UNITS "012.0"

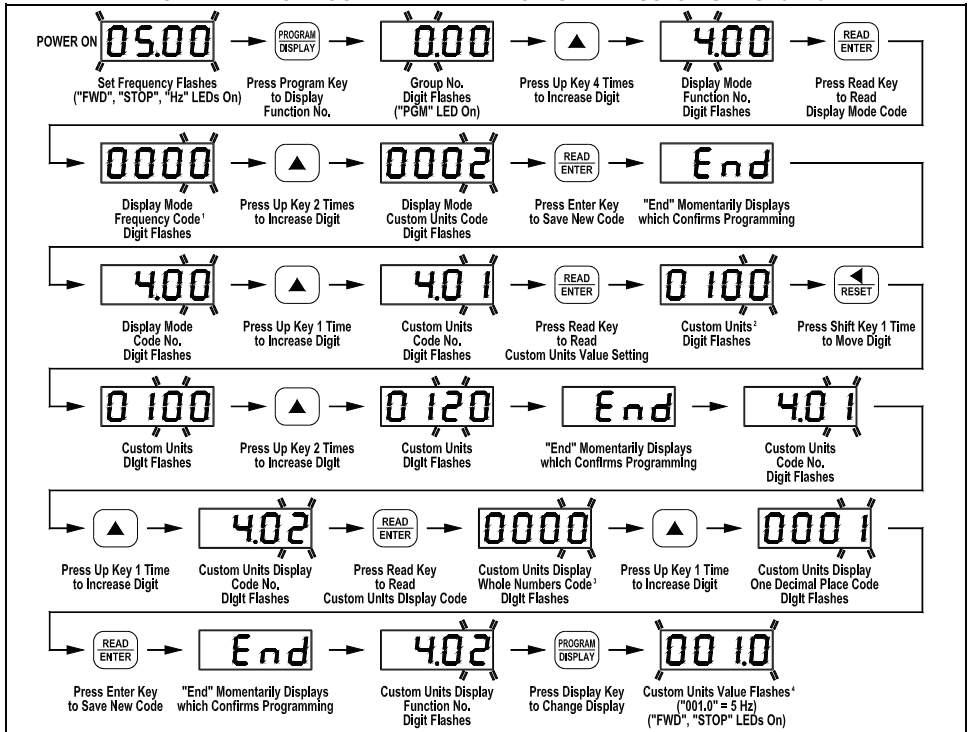

Notes: 1. The factory setting of Display Mode (Function No. 4.00) is Frequency ("0000"). 2. The factory setting of Custom Units Significant Digits (Function No. 4.01) is "0100". 3. The factory setting of Custom Units Display (Function No. 4.02) is Whole Numbers ("0000"). 4. The Custom Unit setting "012.0" will be displayed at full speed.

FIGURE 18
FLOW CHART SHOWING
MOTOR CURRENT, MOTOR VOLTAGE, AND BUS VOLTAGE ADDED TO THE BASIC DISPLAY *

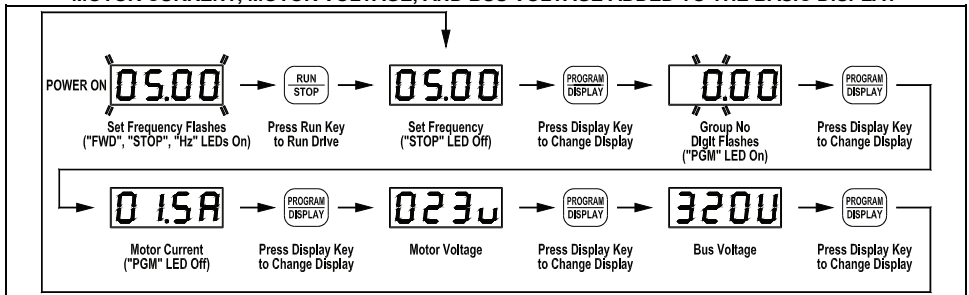

*Function Nos. 4.04 – 4.06 set to "0001".

9.4 **4-DIGIT DISPLAY:** The 4-digit display provides readout of drive status, operating parameters, and faults. See Table 7, for the Digital Readout Codes displayed and their descriptions.



WARNING! Wait at least 1 minute before opening the cover. Be sure the main power switch or circuit breaker is in the "OFF" position before servicing the drive. Do not depend on the green Power On LED (ON), located on the drive's PC board, as shown in Figure 4, on page 9, or the Status LEDs and the 4-Digit Display, located on the front cover, to no longer be illuminated as a guaranteed power off condition.

TABLE 7
DIGITAL READOUT CODES

Display	Description	Display	Description
	Drive Stopped Indicates that the drive is in the Stop Mode. Function No. 4.03 set to "0001".		Parameter Changed Momentarily flashes. Indicates that a parameter has been successfully changed.
	Function No. Example A Function No. consists of a Group No. (digits on left side of the decimal point) and a Group Code No. (digits on right side of the decimal point).		Motor Current Display When the display is set to show Motor Current, the format will be "XX.XA". Function No. 4.04 set to "0001".
	Motor Voltage Display When the display is set to show Motor Voltage, the format will be "XXXu". Function No. 4.05 set to "0001".		Bus Voltage Display When the display is set to show Bus Voltage, the format will be "XXXU". Function No. 4.06 set to "0001".
	Low Voltage Trip Indicates that the AC line input voltage is below the Undervoltage Trip Point specified in Table 3, on page 8.		Low Voltage Recovery Indicates that a Low Voltage Trip occurred and the AC line input voltage has returned to within the operating range specified in Table 3, on page 8.
	Overvoltage Trip Indicates that the AC line input voltage is above the Overvoltage Trip Point specified in Table 3, on page 8.		Overvoltage Recovery Indicates that an Overvoltage Trip occurred and the AC line input voltage has returned to within the operating range specified in Table 3, on page 8.
	Overload Trip (I²t Timeout) Indicates that the motor has been overloaded for an extended period of time.		External Fault Trip Indicates that an external fault has occurred at one of the MFITs of the IODA. Function Nos. 7.00 – 7.06 set to "0008".
	Current Source Trip Indicates that the current signal output (from the IODA) has been opened.		Short Circuit Fault Indicates that the drive detected a short circuit at the motor (phase-to-phase).
	Data Enter Error Indicates that the drive is in the Program Mode and a non-valid parameter change has been attempted.		Keypad Communication Error Indicates that the keypad failed to initialize when the drive is powered up. This is an abnormal condition – contact our Sales Department.
	Flash Memory Error Indicates that a flash memory error on the drive has occurred. This is an abnormal condition – contact our Sales Department.		IODA Error Indicates that the drive has lost communication with the IODA.

9.5 FAULT RECOVERY: The drive monitors many faults. See Function No. 1.05, on page 21, for restarting the drive after a fault has been cleared. See Section 9.4, on page 20, for the Digital Readout Codes. See Section 11, on page 29, for descriptions of the Diagnostic LEDs. See Appendix A, on pages 30 – 49, for IODA faults.

Drive Faults: Undervoltage ("–LU–"), Overvoltage ("–OU–"), Short Circuit at the motor (phase-to-phase) ("–SC–"), and I²t or I-t Fault ("OL–t").

10 PROGRAMMABLE FUNCTON SUMMARY LIST

All functions have been factory set, as shown in the tables on pages 22 – 28. The *Detailed Programmable Function List* (Part No. A42035) is available – contact our Sales Department.

Programming Mode: When the drive is put into the Programming Mode (see Figure 19), a Function No. will be displayed. A Function No. consists of a Group No. (digits on the left side of the decimal point) and a Group No. Code (digits on the right side of the decimal point). The digits can be changed using the Up and Down Keys. The Left Shift Key is used to move the changeable digit.

When the READ Key is pressed, either a Code or Value will be displayed. Codes have specific descriptions. Values have numeric ranges.

To program multiple drives, the optional DownLoad Module™ (Part No. 9582) can be used to upload the drive program and facilitate downloading it to multiple drives.

**FIGURE 19
FUNCTION NO. DESCRIPTION**

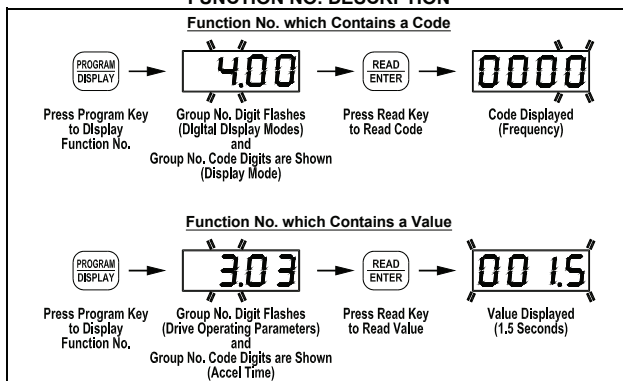

PROGRAMMABLE FUNCTION SUMMARY LIST (Rev. 100.1)

Model Software Revision Codes (Rev. 100.1)

The Programmable Function List, on Pages 22 – 28, is Applicable to Software Revision Code 14/1.01 (or higher).

PROGRAMMABLE FUNCTION GROUPS

Function Group No.	Description
0	Motor and Drive Parameters
1	Run/Stop Mode
2	Frequency Control
3	Drive Operating Parameters
4	Digital Display Modes
5	Onboard Multi-Function Output Relay Operating Mode
6	Drive Status and Reset
7	Multi-Function Input Terminals ⁽¹⁾
8	Multi-Function Output Relays and Output Signal Operation ⁽¹⁾
9	Analog Input Signal Operation ⁽¹⁾
10	Communication Mode ⁽²⁾

Notes: (1) IODA Option Board required. (2) DIAC Option Board required.

FUNCTION GROUP 0 – Motor and Drive Parameters

Function No.	Description	Range/Code	Factory Setting
0.00 *	Rated Motor Frequency (Hz)	0000: 60 Hz 0001: 50 Hz 0002: Special (Set by Function No. 0.05)	0000
0.01 *	Motor Nameplate Current (Amps)	—	(1)
0.02 *	Motor Type	0000: Inverter Duty, TEFC 0001: External Fan Cooled	0000
0.03 *	Torque Mode	0000: Constant Torque (Machinery) 0001: Variable Torque (HVAC)	0000
0.04 *	GFCI Operation ⁽²⁾	0000: GFCI Operation Disabled 0001: GFCI Operation with Standard GFCI 0002: GFCI Operation with Sensitive GFCI	0000
0.05 *	Motor Frequency (Hz) ^{(3), (4)}	30 – 240	60, 50
0.06 *	Motor Nameplate Voltage (% Drive Output) ⁽⁵⁾	0 – 100.0	100 ⁽⁶⁾

Notes: (1) Factory Setting is the drive rated output current. See Table 3, on page 6. This function is used to enter the Motor Nameplate Rated Current, which allows proper operation of the I²t Motor Overload Protection. (2) GFCI operation overrides the Switching Frequency set by Function No. 3.15. (3) When the drive is set for 50 Hz motors (Function No. 0.00 set to "0001"), the Motor Frequency factory setting will automatically reset to 50 Hz. (4) The Motor Frequency for standard 50 Hz or 60 Hz motors is set by Function No. 0.00. For custom motors (e.g., 100 Hz) set Function No. 0.00 to "0002" and Function No. 0.05 to the Motor Nameplate Rated Frequency. (5) This function is used for motors with non-standard nameplate rated voltage (e.g., 80 Volts AC). (6) The factory set output of the drive is 100% of the AC line input voltage. In 60 Hz Mode (Function No. 0.00 set to "0000") the drive output will be 230 Volts, maximum, for 230 Volt motors and 460 Volts, maximum, for 460 Volt motors. In 50 Hz Mode (Function No. 0.00 set to "0001") the drive output will be 220 Volts, maximum, for 220 Volt motors and 400 Volts, maximum, for 400 Volt motors.

**Functions which can only be changed while the drive is in the Stop Mode.*

FUNCTION GROUP 1 – Run/Stop Mode

Function No.	Description	Range/Code	Factory Setting
1.00 *	Run/Stop-Forward/Reverse Control	0000: Keypad 0001: External Contacts ⁽¹⁾ 0002: Communication ⁽²⁾	0000
1.01 *	Forward/Reverse Control	0000: Instant Reverse 0001: Stop Command Must be Given Prior to Reverse Command 0002: Reverse Command Disabled 0003: Forward Command Disabled	0000
1.02 *	Motor Direction	0000: Forward 0001: Reverse	0000
1.03 *	Start Command	0000: Accelerates to Last Set Frequency 0001: Accelerates to Lower Frequency Limit (See Function No. 3.01)	0000
1.04 *	Start Mode	0000: Spin Start 0001: Stop Before Restart	0000
1.05 *	Auto/Manual Start Mode	0000: Manual Start Mode 0001: Manual Start with Ride-Through (Set by Function No. 1.06) 0002: Auto Start After Undervoltage Fault Clears 0003: Auto Start All Faults (Except Short Circuit Fault) ⁽³⁾ 0004: Auto Start All Faults (Except I ² t, I*t, and Short Circuit Faults)	0000
1.06 *	Ride-Through Time (Seconds)	0.0 – 2.0	0.5
1.07 *	Number of Restart Attempts	0 – 10	3
1.08 *	Start Delay Time (Seconds)	0 – 240	0
1.09 *	Stop Mode	0000: Regenerate-to-Stop 0001: Coast-to-Stop 0002: Regeneration with Injection Brake-to-Stop (Set by Function Nos. 1.11 – 1.13)	0000
1.10 *	Holding Torque in Stop Mode (%)	0 – 10	1
1.11	Injection Brake Start Frequency (Hz)	0.00 – 240.0	0.00
1.12	Injection Brake Level (%)	0 – 30	0
1.13	Injection Brake Time (Seconds)	0.0 – 25.5	0.0

Notes: (1) IODA Option Board required. (2) DIAC Option Board required. (3) For Auto Start, Function No. 1.07 must be set to greater than "0".

*Functions which can only be changed while the drive is in the Stop Mode.

FUNCTION GROUP 2 – Frequency Control

Function No.	Description	Code	Factory Setting
2.00 *	Frequency Control	0000: Keypad 0001: Built-In Potentiometer 0002: Analog Signal 1 ⁽¹⁾ 0003: Analog Signal 2 ⁽¹⁾ 0004: Communication ⁽²⁾ 0005: Up/Down Using MFITs ⁽¹⁾	0000
2.01 *	Up Key, Down Key Operation Mode	0000: Frequency Change Requires Enter Command 0001: Direct Frequency Change 0002: Keypad Disable	0000
2.02 *	Jog-Local/Remote ^{(3), (4)}	0000: Jog Enabled 0001: Jog Disabled 0002: Jog Disabled; Local/Remote Enabled (Keypad Operation) ⁽¹⁾ 0003: Jog Disabled; Local/Remote Enabled (Built-In Speed Potentiometer Operation) ⁽¹⁾	0000

Notes: (1) IODA Option Board required. (2) DIAC Option Board required. (3) See Jog Mode (Function No. 3.12), Jog Frequency (Function No. 3.13), and Jog Accel/Decel Time (Function No. 3.14). (4) The Jog function can be reprogrammed for Local/Remote (LCL/REM) Operation. When in Remote Mode Operation, the "JOG/REM" LED will flash.

*Functions which can only be changed while the drive is in the Stop Mode.

FUNCTION GROUP 3 – Drive Operating Parameters

Function No.	Description	Range/Code	Factory Setting
3.00	Stored Set Frequency (Hz)	0.00 – 240.0	5.00
3.01	Lower Frequency Limit (Hz)	0.00 – 240.0	0.00
3.02	Upper Frequency Limit (Hz) ⁽¹⁾	0.00 – 240.0	60.0, 50.0
3.03	Accel Time (Seconds) ⁽²⁾	0.1 – 180.0	1.5
3.04	Decel Time (Seconds) ⁽²⁾	0.3 – 180.0	1.5
3.05	S-Curve Time Accel (Seconds) ⁽²⁾	0.0 – 30.0	0.0
3.06	S-Curve Time Decel (Seconds) ⁽²⁾	0.0 – 30.0	0.0
3.07 *	Skip Frequency (Hz)	0.00 – 240.0	0.00
3.08 *	Skip Frequency Bandwidth (\pm Hz)	0.00 – 2.00	0.00
3.09 *	Motor Overload Protection	0000: I ² t with Current Limit Enabled 0001: I ² t with Current Limit Enabled	0000
3.10 *	I ² t with Current Limit Trip Time (Seconds)	1.0 – 20.0	6.0
3.11	Boost Value (%)	0.0 – 28.0	7.0
3.12 *	Jog Mode	0000: Momentary 0001: Latching	0000
3.13	Jog Frequency (Hz)	0.00 – 240.0	5.00
3.14	Jog Accel/Decel Time (Seconds)	0.3 – 10.0	1.0
3.15 *	Switching Frequency (kHz)	0000: 8 0001: 10 0002: 12	0000
3.16	Flux Vector Compensation (%)	0.0 – 10.0	5.0

Notes: (1) When the drive is set for 50 Hz motors (Function 0.00 set to "0001"), the Upper Frequency Limit factory setting will automatically reset to 50 Hz. (2) Time set for Function Nos. 3.03 and 3.04 must be equal to or greater than the time set for Function Nos. 3.05 and 3.06, respectively.

*Functions which can only be changed while the drive is in the Stop Mode.

FUNCTION GROUP 4 – Digital Display Modes

Function No.	Description	Range/Code	Factory Setting
4.00	Display Mode	0000: Frequency 0001: RPM ⁽¹⁾ 0002: Custom Units	0000
4.01	Custom Units Significant Digits	0 – 9999	100
4.02	Custom Units Display	0000: Whole Numbers 0001: One Decimal Place 0002: Two Decimal Places 0003: Three Decimal Places	0000
4.03	Display in Stop Mode	0000: Displays Last Run Setting 0001: Displays "StoP" 0002: Displays "0000"	0000
4.04	Motor Current Display ^{(2), (3)}	0000: Disabled 0001: Enabled	0000
4.05	Motor Voltage Display ^{(2), (3)}	0000: Disabled 0001: Enabled	0000
4.06	Bus Voltage Display ^{(2), (3)}	0000: Disabled 0001: Enabled	0000

Notes: (1) Based on 4-pole motor. (2) The Display Key is used to toggle between displays. See Figure 18, on page 19. (3) If Motor Current Display is enabled, the display will show "XX.XA". If Motor Voltage Display is enabled, the display will show "XXXu". If Bus Voltage Display is enabled, the display will show "XXXU".

FUNCTION GROUP 5 – Onboard Multi-Function Output Relay Operating Mode

Function No.	Description	Range/Code	Factory Setting
5.00	Relay Operation Mode	0000: Run 0001: Fault ⁽¹⁾ 0002: Target Frequency (Function No. 5.01 ± Function No. 5.02) 0003: Frequency Threshold Level (> Function No. 5.01 – Function No. 5.02) ⁽²⁾ 0004: Frequency Threshold Level (< Function No. 5.01 + Function No. 5.02) ⁽³⁾ 0005: I _t or I _{st} Fault 0006: Load Loss (See Function No. 5.03)	0000
5.01	Frequency Reached (Hz)	0.00 – 240.0	0.00
5.02	Frequency Bandwidth (± Hz)	0.00 – 30.00	1.00
5.03	Load Loss Threshold ⁽⁴⁾ (% Motor Current) (Set by Function No. 0.01)	25 – 90	60

Note: (1) The Multi-Function Output Relay Contacts will change state due to all Faults and Recovered Faults. (2) The Multi-Function Output Relay will activate above the setting in Function No. 5.01 and deactivate below the setting in Function No. 5.01 minus the setting in Function No. 5.02. (3) The Multi-Function Output Relay will activate below the setting in Function No. 5.01 and deactivate above the setting in Function No. 5.01 plus the setting in Function No. 5.02. (4) The Load Loss Threshold function is not functional during acceleration/deceleration or Stop Mode.

FUNCTION GROUP 6 – Drive Status and Reset

Function No.	Description	Code	Factory Setting
6.00 *	Software Version	—	—
6.01 *	Drive Horsepower	—	—
6.02 *	Fault Log 1	—	—
6.03 *	Fault Log 2	—	—
6.04 *	Fault Log 3	—	—
6.05 **	Reset Drive to Factory Setting	1110: 50 Hz Operation 1111: 60 Hz Operation	0000

*Read only.

**Functions which can only be changed while the drive is in the Stop Mode.

FUNCTION GROUP 7 – Multi-Function Input Terminals (IODA Option Board Required)

Function No.	Description	Range/Code	Factory Setting
7.00 *	Multi-Function Input Terminal 1 ⁽¹⁾	0000: Preset Frequency Operation ⁽²⁾ 0001: Preset Frequency Operation ⁽²⁾	0000
7.01 *	Multi-Function Input Terminal 2 ⁽¹⁾	0002: Preset Frequency Operation ⁽²⁾ 0003: Up Frequency Command (See Function No. 7.14) ⁽³⁾	0001
7.02 *	Multi-Function Input Terminal 3 ⁽¹⁾	0004: Down Frequency Command (See Function No. 7.14) ⁽³⁾	0002
7.03 *	Multi-Function Input Terminal 4 ⁽¹⁾	0005: Accel/Decel 2 (See Function No. 7.16) 0006: Forward/Stop Command ⁽⁴⁾	0009
7.04 *	Multi-Function Input Terminal 5 ⁽¹⁾	0007: Reverse/Stop Command ⁽⁴⁾ 0008: External Fault (N.O. Contact)	0010
7.05 *	Multi-Function Input Terminal 6 ⁽¹⁾	0009: Reset 0010: N.O. Start (2-Wire or 3-Wire Start/Stop) ⁽⁴⁾	0003
7.06 *	Multi-Function Input Terminal 7 ⁽¹⁾	0011: N.C. Stop (3-Wire Start/Stop) ⁽⁴⁾ 0012: External Fault (N.C. Contact)	0004
7.07	Preset Frequency 1 (Hz)	0.00 – 240.0	5.00
7.08	Preset Frequency 2 (Hz)	0.00 – 240.0	10.00
7.09	Preset Frequency 3 (Hz)	0.00 – 240.0	20.00
7.10	Preset Frequency 4 (Hz)	0.00 – 240.0	25.00
7.11	Preset Frequency 5 (Hz)	0.00 – 240.0	30.00
7.12	Preset Frequency 6 (Hz)	0.00 – 240.0	35.00
7.13	Preset Frequency 7 (Hz)	0.00 – 240.0	40.00
7.14	Up/Down Frequency Control Mode	0000: Free-Running ⁽⁵⁾ 0001: Incremental Change (See Function No. 7.15)	0000
7.15	Increment of Up/Down Frequency (Hz)	0.01 – 30.00	1.00
7.16	Accel/Decel 2 Time (Seconds)	0.3 – 180.0	1.5

Note: (1) Each of the 7 Multi-Function Inputs can be programmed for any of the respective function codes ("0000" – "0011"). (2) Preset Frequencies 1 – 7 are obtained by selecting a specific combination of 3 Multi-Function Input Terminals. The specific frequencies are programmed in Function Nos. 7.07 – 7.13. See Appendix A1, on page 33. (3) For Up/Down Frequency Commands (codes "0003" and "0004"), Frequency Control (Function No. 2.00) must be set to Up/Down Using MFITs (code "0005"). (4) For Forward/Reverse Stop Commands (codes "0006" and "0007") and N.O. Start / N.C. Stop (codes "0010" and "0011"), Run/Stop-Forward/Reverse Control (Function No. 1.00) must be set to External Contacts (code "0001"). (5) The rate of change of the "UP" Control for frequency setting, using external contacts, is proportional to the Accel Time setting (Function No. 3.03). The rate of change of the "DOWN" Control for frequency setting, using external contacts, is proportional to the Decel Time Setting (Function No. 3.04).

*Functions which can only be changed while the drive is in the Stop Mode.

FUNCTION GROUP 8 – Multi-Function Output Relays and Output Signal Operation (IODA Required)

Function No.	Description	Range/Code	Factory Setting
8.00 *	Multi-Function Output Relay 1 (Terminals 23 – 25)	0000: Run 0001: Fault ⁽¹⁾ 0002: Target Frequency (Function No. 8.04 ± Function No. 8.05)	0000
8.01 *	Multi-Function Output Relay 2 (Terminals 26 – 28)	0003: Frequency Threshold Level (> Function No. 8.04 – Function No. 8.05) ⁽²⁾ 0004: Frequency Threshold Level (< Function No. 8.04 + Function No. 8.05) ⁽³⁾	0001
8.02 *	Multi-Function Open Collector Output 1 (Terminals 11, 12)	0005: I ^t or I ^t Fault	0002
8.03 *	Multi-Function Open Collector Output 2 (Terminals 13, 14)	0006: Load Loss (See Function No. 5.03) 0007: External Fault 0008: Motor Overload ⁽⁴⁾	0004
8.04	Frequency Set Point (Hz)	0.00 – 240.0	0.00
8.05	Frequency Bandwidth (± Hz)	0.00 – 30.00	1.00
8.06	Analog Output 1 Mode (Terms. 15, 16) (0 – 5 VDC)	0000: Motor Frequency 0003: Bus Voltage 0001: Set Frequency 0004: Motor Current 0002: Motor Voltage	0000
8.07	Analog Output 1 Gain (%)	0 – 200	100
8.08	Analog Output 2 Mode (Terms. 17, 18) (See Function No. 8.09)	0000: Motor Frequency 0003: Bus Voltage 0001: Set Frequency 0004: Motor Current 0002: Motor Voltage	0000
8.09	Analog Output 2 Type ⁽⁵⁾	0000: 0 – 5 VDC 0001: 0 – 20 mA DC 0002: 4 – 20 mA DC	0000
8.10	Analog Output 2 Gain (%)	0 – 200	100

Notes: (1) The Multi-Function Output Relay Contacts and Open Collector Outputs will change state due to all Faults and Recovered Faults. (2) The Multi-Function Output Relay will activate above the setting in Function No. 8.04 and deactivate below the setting in Function No. 8.04 minus the setting in Function No. 8.05. (3) The Multi-Function Output Relay will activate below the setting in Function No. 8.04 and deactivate above the setting in Function No. 8.04 plus the setting in Function No. 8.05. (4) The Multi-Function Output Relay will change state when the I^t or I^t Timer starts. (5) Analog Output 2 Type: For 0 – 5 VDC (code "0000"), set Jumpers J2 and J3, on the IODA, to the "VOLT" position (factory setting). For 0 – 20 mA DC (code "0001") or 4 – 20 mA DC (code "0002"), set Jumpers J2 and J3, on the IODA, to the "CUR" position.

*Functions which can only be changed while the drive is in the Stop Mode.

FUNCTION GROUP 9 – Analog Input Signal Operation (IODA Required)

Function No.	Description	Range/Code	Factory Setting
9.00	Analog Input 1 Gain (%) ⁽¹⁾	0 – 500	100
9.01	Analog Input 1 Slope ⁽¹⁾	0000: Positive 0001: Negative	0000
9.02	Analog Input 1 Offset (%) ⁽¹⁾	0 – 100	0
9.03	Analog Input 1 Type ⁽¹⁾	0000: Unidirectional 0001: Bidirectional	0000
9.04	Analog Input 1 Response Time (mSec) ⁽¹⁾	2 – 100	2
9.05	Analog Input 2 Gain (%) ⁽²⁾	0 – 500	100
9.06	Analog Input 2 Slope ⁽²⁾	0000: Positive 0001: Negative	0000
9.07	Analog Input 2 Offset (%) ⁽²⁾	0 – 100	0
9.08	Analog Input 2 Type ⁽²⁾	0000: Analog Voltage or Current ⁽³⁾ 0001: PWM ⁽⁴⁾	0000
9.09	Analog Input 2 Response Time (mSec) ⁽²⁾	2 – 100	2

Notes: (1) For Analog Input 1 (Function Nos. 9.00 – 9.04), Frequency Control (Function No. 2.00) must be set to Analog Signal 1 (code "0002"). (2) For Analog Input 2 (Function Nos. 9.05 – 9.09), Frequency Control (Function No. 2.00) must be set to Analog Signal 2 (code "0003"). (3) For Current Signal Input, set Jumper J1, on the IODA, to the "CUR" position. (4) 0.15 – 1 kHz (0 – 100% duty cycle).

FUNCTION GROUP 10 – Communication Mode (DIAC Required)

Function No.	Description	Range/Code	Factory Setting
10.00 *	Assigned Communication Station Number	1 – 247	30
10.01	Communications Watchdog Timer	0000: Disabled 0001: Enabled	0000
10.02	Watchdog Timeout (Seconds)	0.50 – 2.00	0.50
10.03	Operational Command	0 0: Stop 1: Run	—
		1 0: Forward 1: Reverse	
		2 0: N/A 1: Fault Reset	
		3 0: JOG-LCL/REM Command Off 1: JOG-LCL/REM Command On	
		4 0: N/A 1: Preset Frequency 1	
		5 0: N/A 1: Preset Frequency 2	
		6 0: N/A 1: Preset Frequency 3	
		7 0: N/A 1: Preset Frequency 4	
		8 0: N/A 1: Preset Frequency 5	
		9 0: N/A 1: Preset Frequency 6	
		10 0: N/A 1: Preset Frequency 7	
		11–15	
10.04	Drive Status	0 0: Stop 1: Run	—
		1 0: Forward 1: Reverse	
		2 0: Normal 1: Fault	
		3 0: JOG-LCL/REM Command Off 1: JOG-LCL/REM Command On	
		4 0: N/A 1: Preset Frequency 1	
		5 0: N/A 1: Preset Frequency 2	
		6 0: N/A 1: Preset Frequency 3	
		7 0: N/A 1: Preset Frequency 4	
		8 0: N/A 1: Preset Frequency 5	
		9 0: N/A 1: Preset Frequency 6	
		10 0: N/A 1: Preset Frequency 7	
		11 0:Jog Momentary Mode 1:Jog Latching Mode	
		12 Reserved	
		13 0:Local 1:Remote	
14, 15	Reserved		
10.05	Drive Status Description	00 Normal Operation	—
		01 Short Circuit Trip	
		02 Current Limit	
		03 Current Limit Trip	
		04 Undervoltage Trip	
		05 Recovered Undervoltage Trip	
		06 Overvoltage Trip	
		07 Recovered Overvoltage Trip	
		08 Stop Mode	
		09 Flash Error	
		10 External Fault Trip (IODA)	
		11 IODA Error	
		12 Phase Loss Trip	
13 Current Source Trip (IODA)			
10.06 **	Communications Error Count	—	—
10.07 **	Motor Voltage	—	—
10.08 **	Motor Current	—	—
10.09 **	Bus Voltage	—	—
10.10 **	Motor Frequency	—	—

*Functions which can only be changed while the drive is in the Stop Mode.

**Read only.

11 STATUS LEDs

The drive's cover contains 8 LEDs which provide indication of the drive's status and operating mode (Hz, PGM, LCL/REM, STOP, FWD, REV, OL, JOG/REM). See Table 8, for a description of the LEDs.



WARNING! Wait at least 1 minute before opening the cover. Be sure the main power switch or circuit breaker is in the "OFF" position before servicing the drive. Do not depend on the Status LEDs or the 4-Digit Display to no longer be illuminated as a guaranteed power off condition.

TABLE 8
LED DESCRIPTIONS

LED	Description
JOG <input type="checkbox"/> REM	Illuminates when Jog is selected. Flashes when the drive is set for Remote Signal Operation.
OL <input type="checkbox"/>	Illuminates when the drive is in Overload.
FWD <input type="checkbox"/>	Illuminates when the drive is in the Forward Direction.
REV <input type="checkbox"/>	Illuminates when the drive is in the Reverse Direction.
STOP <input type="checkbox"/>	Illuminates when the drive is in the Stop Mode.
Hz <input type="checkbox"/>	Illuminates when the display is set to show Output Frequency.
LCL/REM <input type="checkbox"/>	Illuminates when the JOG-LCL/REM Key is reprogrammed for Local (Keypad) and Remote Signal Operation.
PGM <input type="checkbox"/>	Illuminates when the drive is in the Program Mode.

APPENDIX A – OPTIONAL IODA INPUT/OUTPUT MULTI-FUNCTION BOARD

For detailed operation of the IODA, see the *IODA Installation and Operation Instruction Manual (Part No. A40159)*.

The IODA Input/Output Multi-Function Board provides a variety of functions which include preset frequency, up/down frequency control, signal isolation, isolated output voltage for controlling auxiliary devices, output relay contacts, and open collector outputs. The IODA mounts on the drive's PC board with 3 screws (provided). All of the IODA inputs and outputs are isolated from the AC line.

The IODA has a green LED for power (PWR) and a red LED for (STATUS). These LEDs are used to provide operational information of the IODA. See Table 9, on page 31, for a description of the Status LED. See Figure 20, on page 31, for the IODA layout. See Table 10, on page 31, for the IODA Terminal Block TB1 Wire and Tightening Torque Specifications. See Figure 21, on page 32, for the IODA Terminal Block TB1 Layout. See Table 11, on page 32, for the IODA Functions, Features, and Terminal Assignment. See Appendix Sections A1 – A7, on pages 33 – 39, describing *Using of the IODA Multi-Function Input Terminals for Remote Operations*. See Appendix Sections A8 – A12, on pages 40 – 49, for *Other Functions and Features of the IODA*.

Local/Remote Operation: When using the IODA with signal following, it will be necessary to program the drive for Local/Remote Operation. In this mode, the drive frequency setting can be toggled between a process signal and the keypad using the JOG-LCL/REM Key. Set Jog-Local/Remote (Function No. 2.02) to Jog Disabled; Local/Remote Enabled ("0002") to change the JOG-LCL/REM Key from Jog Operation to Local/Remote Operation.

IODA Faults: External Fault Trip ("EF-t") indicates that a Multi-Function Input Terminal (Function Nos. 7.00 – 7.06 set to "0008") has closed (and will change the state of the Multi-Function Output Relay Contacts and the Multi-Function Open Collectors (when Function No. 8.00 to 8.03 is set to "0007")). Current Source Trip ("CS-t") indicates that the current signal output (from the IODA) has been opened. Communication Error ("Err4") indicates that communication between the drive and the IODA has failed.



WARNING! Do not depend on the Status LEDs or the 4-Digit Display to no longer be illuminated as a guaranteed power off condition. Be sure the main power switch or circuit breaker is in the "OFF" position before servicing the drive.

STANDARD FEATURES

- **Signal Input Isolation:** Provides isolation between signal sources and the drive.
- **Potentiometer Operation:** A remote 5 k Ω potentiometer can be used in lieu of the Keypad or the Built-In Potentiometer. The remote potentiometer can be connected for forward, reverse, or bidirectional motor speed control.
- **Multi-Function Input Terminals:** Used for a variety of functions, which include Preset Frequency; Up/Down Frequency Command; Forward/Stop and Reverse/Stop Command; External Fault; Reset; 2-Wire and 3-Wire Start/Stop.
- **Multi-Function Output Relays:** Two Multi-Function Output Relays are provided, which can be programmed for Run, Fault, Target Frequency, Frequency Threshold Level, I²t or I*t Fault, Load Loss, External Fault, and Motor Overload.
- **Multi-Function Open Collector Outputs:** Two Multi-Function Output Relays are provided, which can be programmed for Run, Fault, Target Frequency, Frequency Threshold Level, I²t or I*t Fault, Load Loss, External Fault, and Motor Overload.
- **Isolated Signal Output:** Two isolated analog signal outputs are provided, which can be used to monitor Motor Frequency, Set Frequency, Motor Voltage Bus Voltage, and Motor Current. Analog Output 1 provides a 0 – 5 Volt DC signal output. Analog Output 2 can be programmed for 0 – 5 Volt DC, 4 – 20 mA DC, or 0 – 20 mA DC.
- **Selectable Jumpers:** For voltage or current signal selection.
- **Multi-Turn Trimpots:** For fine adjustment and attenuation of signal inputs.
- **LEDs:** The green power on LED (PWR) indicates that power is applied to the IODA from the drive. The red status LED (STATUS) provides indication of the IODA operation.
- **Barrier Terminal:** All connections to the IODA are made via the barrier terminal block. All terminal block connections of the IODA are isolated from the AC line.
- **Easy Installation:** Uses 3 screws (provided) for mounting and a ribbon cable for wiring to the drive.

FIGURE 21
IODA TERMINAL BLOCK TB1 LAYOUT

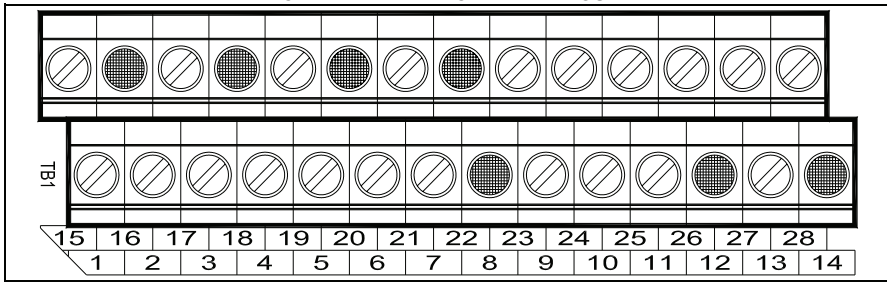

Common Terminals "8", "12", "14", "16", "18", "20", "22" are all internally connected and are shown shaded.

TABLE 11
IODA FUNCTIONS, FEATURES, AND TERMINAL ASSIGNMENT

Multi-Function Input Terminal Codes	Terminal Assignment						
	MFIT ¹ (Digital Inputs)	Power Supply ²	Multi-Function Outputs ²	Analog Outputs ²	Analog Inputs ²	Relay Outputs ³	
0000: Preset Frequency Operation ¹	1 – 7	8 Common	11 Open Collector 1	15 Analog Out 1	19 Analog In 1	23 Relay 1 N.O.	
0001: Preset Frequency Operation ¹			9 +5 Volts	12 Common	16 Common	20 Common	24 Relay 1 Common
0002: Preset Frequency Operation ¹		10 -5 Volts		13 Open Collector 2	17 Analog Out 2	21 Analog In 2	25 Relay 1 N.C.
0003: Up Frequency Command (See Function No.7.14)				14 Common	18 Common	22 Common	26 Relay 2 N.O.
0004: Down Frequency Command (See Function No. 7.14)				27 Relay 2 Common	28 Relay 2 N.C.		
0005: Accel/Decel 2 (See Function No. 7.16)							
0006: Forward/Stop Command							
0007: Reverse/Stop Command							
0008: External Fault (N.O. Contact)							
0009: Reset							
0010: N.O. Start (2-Wire or 3-Wire Start/Stop)							
0011: N.C. Stop (3-Wire Start/Stop)							
0012: External Fault (N.C. ontact)							

Notes: 1. Multi-Function Input Terminals "1" – "7" can be programmed for: 7 Preset Frequencies*, Up or Down Frequency Command, Accel/Decel 2, Forward/Stop, Reverse/Stop, External Fault, Reset, and 2-Wire/3-Wire Start/Stop. 2. Common Terminals 8, 12, 14, 16, 18, 20, and 22 are all internally wired together and can be used with any of the Multi-Function Input Terminals "1" – "7". 3. Relay 1 Common (Terminal 24) is the contact common only for Relay 1. Relay 2 Common (Terminal 27) is the contact common only for Relay 2.

*The 7 Preset Frequencies are obtained using a combination of Terminals 1, 2, 1+2, 3, 1+3, 2+3, 1+2+3.

TABLE 12
MULTI-FUNCTION INPUT TERMINAL, FUNCTION NO., AND CODE ASSIGNMENT

MFIT:	1	2	3	4	5	6	7
Function No.:	7.00	7.01	7.02	7.03	7.04	7.05	7.06
Factory Code Setting:	0000	0001	0002	0009	0010	0003	0004
Code Description:	Preset Frequency Operation	Preset Frequency Operation	Preset Frequency Operation	Reset	2-Wire N.O. Start/Stop	Up Frequency Command	Down Frequency Command

Each Multi-Function Input Terminal is controlled by a specific Function No.

Although factory set to a specific code, they can also be reprogrammed to any Function Code "0000" – "0012" listed in Table 11, above. Also see Function Group 7, on page 26.

USING IODA MULTI-FUNCTION INPUT TERMINALS FOR REMOTE OPERATIONS

A1. PRESET FREQUENCIES

The drive is factory programmed for 7 Preset Frequencies, which can be selected using remote switches or contacts connected to Multi-Function Input Terminals "1" – "3". See Table 13, for drive programming. See Figure 22, for connections. See Table 14, on page 34, for the Multi-Function Input Terminals to select for the preset frequencies.

The 7 Preset Frequencies are obtained using a combination of Multi-Function Input Terminals 1, 2, 1+2, 3, 1+3, 2+3, 1+2+3. The Preset Frequencies can be changed from their factory settings by reprogramming Function Nos. 7.07 – 7.13.

8th Preset Frequency: If none of the Multi-Function Input Terminals are activated, the drive will operate at the Stored Set Frequency (Function No. 3.00) of 5.00 Hz. If the 8th Preset Frequency is not required, set Function No. 3.00 to 00.00 Hz.

Note: For Preset Frequency Operation only, the drive does not have to be reprogrammed for External Contacts Operation. Multi-Function Input Terminals "1" – "3" are factory set to codes "0000", "0001", and "0002", which automatically sets the drive for Preset Frequency Operation.

TABLE 13
PRESET FREQUENCY SELECTION WITH 2-WIRE START/STOP PROGRAMMING

Function No.	Code/Range
1.00: Run/Stop-Forward/Reverse Control	0001: External Contacts
3.00: Stored Set Frequency	00.00 Hz
7.00: Multi-Function Input Terminal 1	0000: Preset Frequency Operation*
7.01: Multi-Function Input Terminal 2	0001: Preset Frequency Operation*
7.02: Multi-Function Input Terminal 3	0002: Preset Frequency Operation*
7.04: Multi-Function Input Terminal 5	0010: N.O. Start*

*Factory setting.

FIGURE 22
PRESET FREQUENCY SELECTION
WITH 2-WIRE START/STOP CONNECTIONS

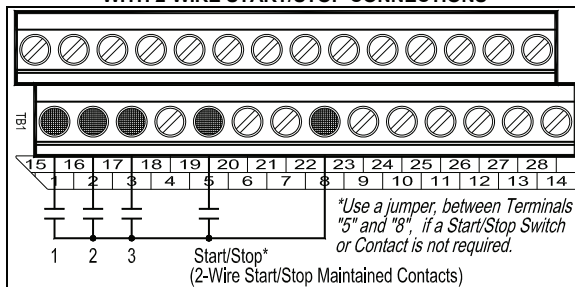

Note: Use Function Nos. 7.07 – 7.13 to program the desired Preset Frequencies.

**TABLE 14
PRESET FREQUENCY SELECTION**

Multi-Function Input Terminals to Select			Preset Frequency		
Terminal 1	Terminal 2	Terminal 3	No.	Function No.	Hz (Factory Setting)
Function No. 7.00 Set to "0000"*	Function No. 7.01 Set to "0001"*	Function No. 7.02 Set to "0002"*			
•			1	7.07	5.00
	•		2	7.08	10.00
•	•		3	7.09	20.00
		•	4	7.10	25.00
•		•	5	7.11	30.00
	•	•	6	7.12	35.00
•	•	•	7	7.13	40.00

*Factory setting.

A2. UP/DOWN FREQUENCY COMMAND

The Multi-Function Input Terminals can be used for remote Up/Down Frequency Control in lieu of the Keypad. See Table 15, on page 35, for drive programming. See Figure 23, on page 35, for connections.

Connect the Up and Down Switches or Contacts to Multi-Function Input Terminals "6" and "7", which are factory set for Up and Down Frequency Command ("0003" and "0004"). The common of the switches or contacts can be connected to any available common terminal ("8", "12", "14", "16", "18", "20", "22").

Application Notes: **1.** The Up/down Frequency Command Operation can be programmed for "Free-Running" or "Incremental" frequency change by setting Up/Down Frequency Control Mode (Function No. 7.14) for "Free Running" ("0000" (factory setting)) or "Incremental Change" ("0001"). **2.** In "Free Running" Mode, the rate of change of the "Up" control is proportional to the Accel Time (Function No. 3.03) and the rate of change of the "Down" control is proportional to the Decel Time (Function No. 3.04). **3.** In "Incremental Change" Mode, the step of change of the "Up" or "Down" control is set by Function No. 7.15 (range is 0.01 – 30.00 Hz (factory set to 1.00 Hz)).

Free-Running Operation: Close the Start/Stop Switch or Contact to put the drive into the Run Mode. When the Up Switch or Contact is closed, the drive output frequency will increase for the duration of the switch or contact closure. When the Up Switch or Contact is opened, the drive output frequency will stop increasing. When the Down Switch or Contact is closed, the drive output frequency will decrease for the duration of the switch or contact closure. When the Down Switch or Contact is opened, the drive output frequency will stop decreasing. Open the Start/Stop Switch or Contact to put the drive into the Stop Mode.

Incremental Operation: Close the Start/Stop Switch or Contact to put the drive into the Run Mode. For each activation of the Up Switch or Contact, the drive output frequency will increase incrementally, equal to the frequency set by Function No.7.15 (factory set to 1.00 Hz). For each activation of the Down Switch or Contact, the drive output frequency will decrease incrementally, equal to the frequency set by Function No. 7.15 (factory set to 1.00 Hz). Open the Start/Stop Switch or Contact to put the drive into the Stop Mode.

Note: In Incremental Operation, if the Up or Down Switch or Contact is maintained for longer than 2 seconds, the drive output frequency will "free run" up or down in increments set by Function No. 7.15, for the duration of the switch or contact closure. The rate of change is equal to the Accel/Decel settings in Function Nos. 3.03 and 3.04. When the switch or contact is opened, the drive output frequency will stop changing.

TABLE 15
UP/DOWN FREQUENCY CONTROL PROGRAMMING

Function No.	Code/Range
1.00: Run/Stop-Forward/Reverse Control	0001: External Contacts
2.00: Frequency Control	0005: Up/Down Using MFITs
7.04: Multi-Function Input Terminal 5	0010: N.O. Start*
7.05: Multi-Function Input Terminal 6	0003: Up Frequency Command*
7.06: Multi-Function Input Terminal 7	0004: Down Frequency Command.
7.14: Up/Down Frequency Control Mode	0000: Free-Running 0001: Incremental
7.15: Increment of Up/Down Frequency**	0.01 – 30.00 Hz: Set to Desired Frequency

*Factory setting.

**Use with Function No. 7.14 code "0001" only.

FIGURE 23
UP/DOWN FREQUENCY CONTROL
WITH 2-WIRE START/STOP CONNECTIONS

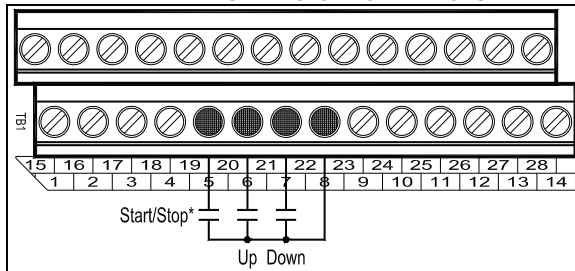

*Use a jumper, between Terminals "5" and "8", if a Start/Stop Switch or Contact is not required.

A3. ACCEL/DECCEL 2

The drive provides a secondary Accel/Decel Time setting, which can be remotely selected with a normally open switch or contact connected to a Multi-Function Input Terminal. See Table 16, for drive programming. See Figure 24, on page 36, for connections.

Connect the Accel/Decel 2 Switch or Contact to any Multi-Function Input Terminal "1" – "7". Terminal "6" has been arbitrarily chosen for Accel/Decel 2. Connect the common of the switch or contact to any available common terminal ("8", "12", "14", "16", "18", "20", "22").

Operation: When the Accel/Decel 2 Switch or Contact is closed, the Accel/Decel 2 setting is selected. When the Accel/Decel 2 Switch or Contact opened, the drive reverts to the Accel/Decel settings in Function Nos. 3.03 and 3.04. Accel/Decel 2 overrides the Accel and Decel settings in Function Nos. 3.03 and 3.04.

TABLE 16
ACCEL/DECCEL "2" PROGRAMMING

Function No.	Code/Range
7.05: Multi-Function Input Terminal 6	0005: Accel/Decel 2
7.16: Accel/Decel 2 Time	0.3 – 180.0: Set to Desired Time*

*Factory set to 1.5 seconds.

FIGURE 24
ACCEL/DECEL "2" CONENCTIONS

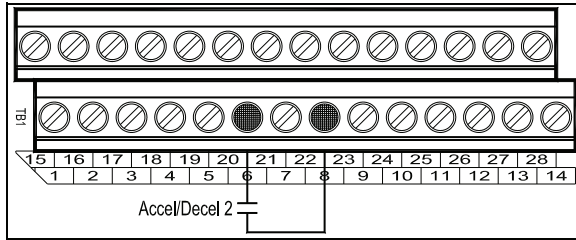

A4. FORWARD/STOP AND REVERSE/STOP

Remote Forward/Stop and Reverse/Stop operation can be performed by connecting switches or contacts to the Multi-Function Input Terminals. See Table 17, for drive programming. See Figure 25, for connections.

Connect the Start/Stop Switch or Contact to Multi-Function Input Terminal "5", which is factory set for N.O. Start ("0010"). Connect the Forward/Stop and Reverse/Stop Switches or Contacts to any Multi-Function Input Terminals "1" – "7". Terminals "3" and "4" have been arbitrarily chosen for Forward/Stop and Reverse Stop. Connect the common of the switches or contacts to any available common terminal ("8", "12", "14", "16", "18", "20", "22").

Operation: When the Forward/Stop Switch or Contact is closed, the drive will run in the forward direction. When the Forward/Stop Switch or Contact is opened, the drive will stop. When the Reverse/Stop Switch or Contact is closed, the drive will run in the reverse direction. When the Reverse/Stop Switch or Contact is opened, the drive will stop.

TABLE 17
FORWARD/STOP-REVERSE/STOP PROGRAMMING

Function No.	Code
1.00: Run/Stop-Forward/Reverse Control	0001: External Contacts
7.02: Multi-Function Input Terminal 3	0006: Forward/Stop Command
7.03: Multi-Function Input Terminal 4	0007: Reverse/Stop Command
7.04: Multi-Function Input Terminal 5	0010: N.O. Start*

FIGURE 25
FORWARD/STOP-REVERSE/STOP CONNECTIONS

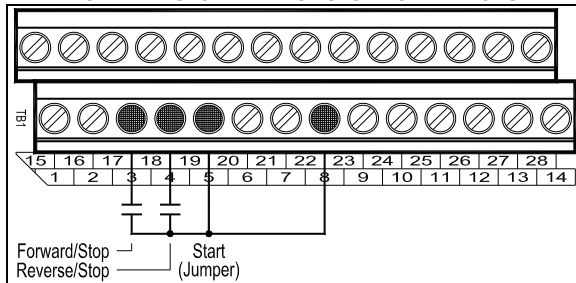

A5. EXTERNAL FAULT

The Multi-Function Input Terminals can be used to "stop" the drive when a fault condition occurs elsewhere in the equipment. The connection to the Multi-Function Input Terminal can be from a normally open or normally closed relay contact or PLC. See Table 18, for drive programming. See Figure 26, for connections.

Note: For a normally open contact, program the respective Multi-Function Input Terminal to "0008". For a normally closed contact, program the respective Multi-Function Input Terminal to "0012".

Connect the auxiliary equipment contact to any Multi-Function Input Terminal "1" – "7". Terminal "5" has been arbitrarily chosen for External Fault. Connect the common of the circuit to any available common terminal ("8", "12", "14", "16", "18", "20", "22").

Operation: When the circuit is activated, the drive will "stop" and the display of the drive will show "EF-t". In order to restart the drive, after the fault has been cleared, either press the Reset Key on the Keypad or use an external contact connected to Multi-Function Input Terminal "4".

APPLICATION NOTES FOR AUTO/MANUAL START MODE (FUNCTION NO. 1.05)

After the External Fault has been Cleared:

1. If the drive is set for Manual Start Mode ("0000" (factory setting)), Manual Start with Ride-Through ("0001"), or Auto Start After Undervoltage Fault Clears ("0002"), it will have to be manually restarted after the external fault has been cleared. Use the Reset Key on the Keypad or the external Reset Switch or Contact to restart the drive.
2. If the drive is set for Auto Start All Faults (Except Short circuit Fault) ("0003"), it will automatically restart after the external fault has been cleared, for the number of restart attempts set in Function No. 1.07 (factory set to 3). After which, the drive will have to be restarted using the Reset Key on the Keypad or the external Reset Switch or Contact.
3. If the drive is set for Auto Start All Faults (Except 1st, 1st, and Short Circuit Faults) ("0004"), it will automatically restart after the external fault has been cleared.

⚠ CAUTION! External Fault is not to be used as an Emergency Stop or safety disconnect since it is not fail-safe. Use only the AC line for this purpose.

**TABLE 18
EXTERNAL FAULT PROGRAMMING**

Function No.	Code
7.03:Multi-Function Input Terminal 4	0009: Reset*
7.04:Multi-Function Input Terminal 5	0008: External Fault (N.O. Contact) 0012: External Fault (N.C. Contact)

*Factory setting.

**FIGURE 26
EXTERNAL FAULT CONNECTIONS**

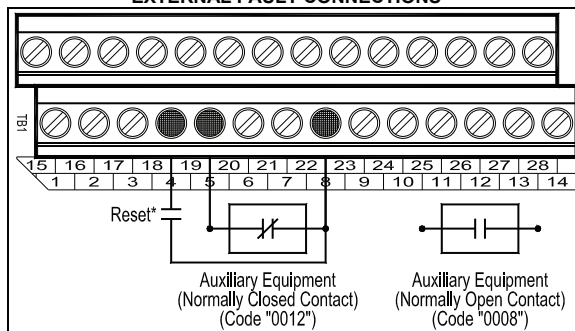

*Optional.

A6. RESET

It is advisable to connect a momentary normally open switch or contact to Multi-Function Input Terminal "4". This allows the drive to be restarted after a fault has been cleared. See Table 19, for drive programming. See Figure 27, for connections.

CAUTION! If a maintained Reset Switch or Contact is used and kept in the closed position while the drive is in the Run Mode (Start hard wired or the Start/Stop switch is in the "Start" position) and a direction is selected, the drive will automatically restart after a fault has been cleared.

Connect the Reset Switch or Contact to Multi-Function Input Terminal "4", which is factory set to Reset ("0009"). Terminal "4" has been arbitrarily chosen for Reset. Connect the common of the switch or contact to any available common terminal ("8", "12", "14", "16", "18", "20", "22").

Operation: When a fault has been cleared, momentarily activate the Reset switch or Contact to reset the drive.

**TABLE 19
RESET PROGRAMMING**

Function No.	Code
7.03: Multi-Function Input Terminal 4	0009: Reset*

*Factory setting.

**FIGURE 27
RESET CONNECTIONS**

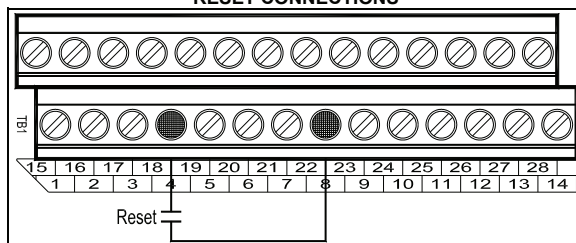

A7. 2-WIRE AND 3-WIRE START/STOP

A remote Start/Stop Switch or Contact can be used to start and stop the motor in lieu of the RUN/STOP Key on the Keypad. The Start/Stop Switch or Contact can be connected for 2-Wire or 3-Wire configuration, as described below.

2-WIRE START/STOP SWITCH OR CONTACT CONNECTION

2-Wire Start/Stop requires a maintained switch or contact. Connect the switch or contact to Multi-Function Input Terminal "5", which has been factory programmed for N.O. Start, and to Terminal "8" (common). See Table 20, for drive programming. See Figure 28, on page 39, for connections.

Set Run/Stop-Forward/Reverse Control (Function No. 1.00) to External Contacts ("0001"). Multi-Function Input Terminal "5" (Function No. 7.04) is factory set for N.O. Start ("0010").

Note: Function code "0011" should not be programmed when using 2-Wire Start/Stop.

**TABLE 20
2-WIRE START/STOP PROGRAMMING**

Function No.	Code/Range
1.00: Run/Stop-Forward/Reverse Control	0001: External Contacts
7.04: Multi-Function Input Terminal 5	0010: N.O. Start*

*Factory setting.

**FIGURE 28
2-WIRE START/STOP CONNECTIONS**

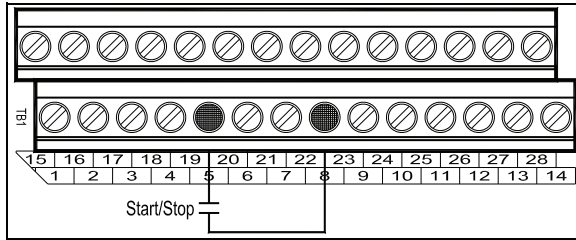

3-WIRE START/STOP SWITCH OR CONTACT CONNECTION

3-Wire Start/Stop requires momentary switches or contacts. Connect the normally open side of the switch or contact to Multi-Function Input Terminal "5". Connect the normally closed side of the switch or contact to any other Multi-Function Input Terminal "1" – "7". Connect the common of the switches or contacts to Terminal "8". See Table 21, for drive programming. See Figure 29, for connections.

Set Run/Stop Mode (Function No. 1.00) to External Contacts ("0001"). Multi-Function Input Terminal "5" (Function Nos. 7.04) is factory set for N.O Start ("0010"). Set the respective Multi-Function Input Terminal (Function Nos. 7.00 – 7.06), which will be used for N.C. Stop, to "0011". In Figure 29, Multi-Function Input Terminal "6" has been arbitrarily chosen for N.C. Stop.

Notes: 1. When an MFIT (Terminal 2) is assigned code "0011", the MFIT (Terminal 1) assigned to code "0010" automatically changes from maintained to momentary operation. 2. When using 3-Wire Start/Stop, "Stop" will override "Start", even if the Start Switch or Contact is kept in the "Start" position.

**TABLE 21
3-WIRE START/STOP PROGRAMMING**

Function No.	Code/Range
1.00: Run/Stop-Forward/Reverse Control	0001: External Contacts
7.04: Multi-Function Input Terminal 5	0010: N.O. Start*
7.05: Multi-Function Input Terminal 6	0011: N.C. Stop

*Factory setting.

**FIGURE 29
3-WIRE START/STOP CONNECTIONS**

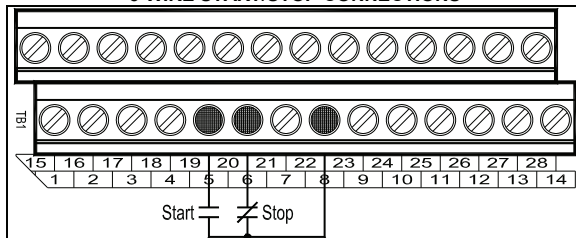

A8. SIGNAL FOLLOWING

An analog voltage (unidirectional or bidirectional), current, or PWM signal input can be used to control motor speed in lieu of the Keypad. The drive output will linearly follow the signal input. The inputs can be programmed for the desired gain, slope, offset, and response time.

Analog Input 1 is used for a DC voltage signal which has a positive or negative slope and is unidirectional or bidirectional. Analog Input 2 is used for a DC voltage, current, or PWM signal with a positive or negative slope and is unidirectional.

Local/Remote Operation: When using the IODA with signal following or remote start/stop, it is desirable to program the drive for Local/Remote Operation. In this mode, the drive frequency setting can be toggled between a process signal and the keypad using the JOG-LCL/REM Key. The following functions can be switched between "remote" and "local" (Keypad) operation: Start/Stop, Forward/Reverse, Analog Signal Inputs 1 and 2, and Up/Down Frequency Control.

Set Jog-Local/Remote (Function No. 2.02) to Jog Disabled; Local/Remote Enabled ("0002") to change the JOG-LCL/REM Key from Jog Operation to Local/Remote Operation.

Note: To stop the drive using the Keypad, when in Remote Operation, first press the JOG-LCL/REM Key and then the Stop Key.

Operation with a Positive Slope Signal: When the signal input is increased, the drive output frequency will increase. When the signal input is decreased, the drive output frequency will decrease. See Figure 30.

Operation with a Negative Slope Signal: When the signal input is increased, the drive output frequency will decrease. When the signal input is decreased, the drive output frequency will increase. See Figure 31, on page 41.

FIGURE 30
ANALOG INPUT "1" AND "2" SIGNAL GAIN AND OFFSET WITH POSITIVE SLOPE
(LOW-TO-HIGH SIGNAL) (FUNCTION NO. 9.01 OR 9.06 SET TO "0000")

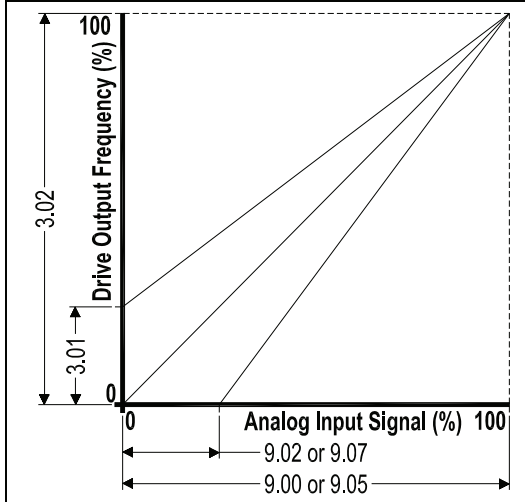
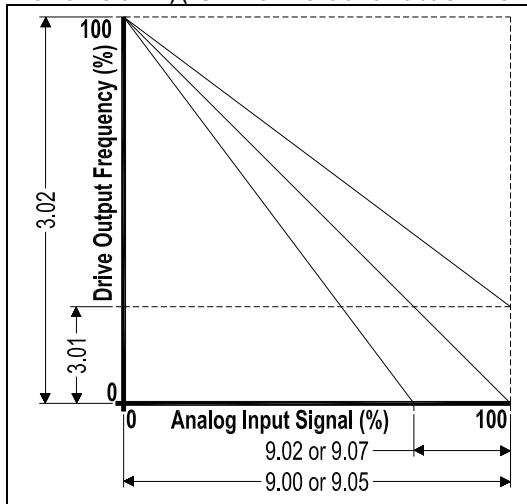

FIGURE 31
ANALOG INPUT "1" AND "2" SIGNAL GAIN AND OFFSET WITH NEGATIVE SLOPE
(HIGH-TO-LOW SIGNAL) (FUNCTION NO. 9.01 OR 9.06 SET TO "0001")



ANALOG INPUT "1"

See Table 22, for Analog Input 1 electrical ratings.

Connect the signal input to Terminal "19" and the common to Terminal "20". Connect the Start (Jumper) to Terminal "5", which is factory set for N.O. Start ("0010") and to any available common terminal ("8", "12", "14", "16", "18" "20", "22"). See Table 23, on page 42, for drive programming. See Figure 32, on page 42, for connections.

MAX1 Trimpot: If the Analog Input 1 signal is higher than 5 Volts, use Trimpot MAX1 to attenuate it. Apply the maximum signal input and set the drive for full speed output and observe the display. Rotate Trimpot MAX1 counter clockwise until the drive output frequency begins to drop. Then, rotate Trimpot MAX1 clockwise until the display returns to the maximum output frequency.

Set the signal Slope and Type and adjust the Gain, Offset, and Response Time as desired. See Figure 30, on page 40, and Figure 31, above.

TABLE 22
ANALOG INPUT "1" ELECTRICAL RATINGS

Parameter	Specification	Factory setting
Voltage Range (Volts DC)	0 – ±2.5 thru 0 – ±25	0 – 5
MAX1 Scaling Trimpot Range (Volts DC)	0 – 24	5

TABLE 23
ANALOG INPUT "1" SIGNAL VOLTAGE FOLLOWING PROGRAMMING

Function No.	Code/Range
2.00:Frequency Control	0002: Analog Signal 1
9.00:Analog Input 1 Gain	0 – 500: Set to the Desired Gain
7.04:Multi-Function Input Terminal 5	0010: N.O. Start*
9.01:Analog Input 1 Slope	0000: Positive 0001: Negative
9.02:Analog Input 1 Offset	0 – 100: Set to the Desired Offset
9.03:Analog Input 1 Type	0000: Unidirectional 0001: Bidirectional
9.04:Analog Input 1 Response Time (mSec)	2 – 100: Set to the Desired Time

*Factory setting.

FIGURE 32
ANALOG INPUT "1" SIGNAL VOLTAGE FOLLOWING CONNECTIONS

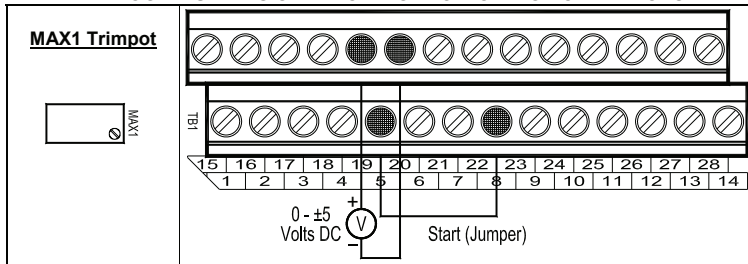

ANALOG INPUT "2"

See Table 24, on page 43, for Analog Input 2 electrical ratings.

Voltage Signal Input: Set Jumper J1 to the "VOLT" position (factory setting).

Current Signal Input: Set Jumper J1 to the "CUR" position.

PWM Signal Input: Set Jumper J1 to the "VOLT" position (factory setting).

Connect the signal input to Terminal "21" and the common to Terminal "22". Connect the Start (Jumper) to Terminal "5", which is factory set for N.O. Start ("0010") and to any available common terminal ("8", "12", "14", "16", "18", "20", "22"). See Table 25, on page 43, for drive programming. See Figure 33, on page 43, for connections.

MAX2 Trimpot: If the Analog Input 2 signal voltage is higher than the input signals specified in Table 16, on page 30, use Trimpot MAX2 to attenuate it. Apply the maximum signal input and set the drive for full speed output and observe the display. Rotate Trimpot MAX2 counter clockwise until the drive output frequency begins to drop. Then rotate Trimpot MAX2 clockwise until the display returns to the maximum output frequency. Set the signal slope and adjust the gain, offset, and response time as desired.

TABLE 24
ANALOG INPUT "2" ELECTRICAL RATINGS

Parameter	Specification	Factory setting
Voltage Range (Volts DC)	0 – ±2.5 thru 0 – ±25	0 – 5
MAX2 Scaling Trimptot Range (Volts DC)	0 – 24	5
Current Range (mA DC)	0 – 20*	–
Input Impedance for Current Mode (Ω)	270	–
PWM (kHz, Duty Cycle)	0.15 – 1, 0 – 100	–

**If using 4 – 20 mA DC signal input, the offset setting in Function No. 9.07 must be increased from "0%" (factory setting) to "20%". Set Jumper J1 to the "CUR" position.*

TABLE 25
ANALOG INPUT "2" SIGNAL CURRENT FOLLOWING PROGRAMMING

Function No.	Code/Range
2.00: Frequency Control	0003: Analog Signal 2
9.05: Analog Input 2 Gain	0 – 500: Set to the Desired Gain
7.04: Multi-Function Input Terminal 5	0010: N.O. Start*
9.06: Analog Input 2 Slope	0000: Positive 0001: Negative
9.07: Analog Input 2 Offset	0 – 100: Set to the Desired Offset
9.08: Analog Input 2 Type	0000: Analog Voltage or Current
9.09: Analog Input 2 Response Time (mSec)	2 – 100: Set to the Desired Time

**Factory setting.*

FIGURE 33
ANALOG INPUT "2" SIGNAL CURRENT FOLLOWING CONNECTIONS

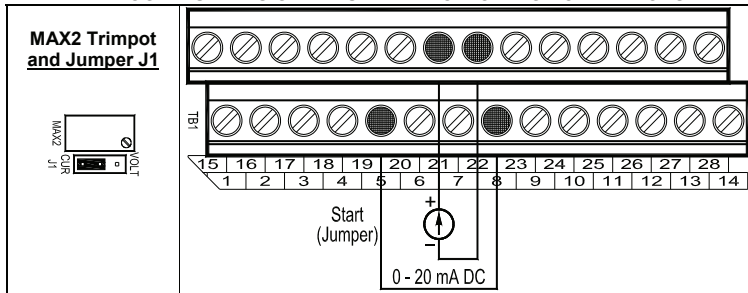

A9. ANALOG SIGNAL OUTPUT

Two analog signal outputs are provided, which will linearly follow the parameter programmed in Analog output 1 Mode (Function No. 8.06) and Analog Output 2 Mode (Function No. 8.08). They can be used to monitor Motor Frequency, Set Frequency, Motor Voltage, Bus Voltage, and Motor Current. See Figure 34, on page 44, for Analog Output 1 and 2 Gain settings (factory set to 100%). See Table 26, for Analog Outputs 1 and 2 electrical ratings. See Table 27, on page 44, for drive programming. See Figure 35, on page 44, for connections.

Analog Output 1 provides a voltage signal output. Analog Output 2 provides a voltage or current signal output.

TABLE 26
ANALOG OUTPUTS "1" AND "2" ELECTRICAL RATINGS

Parameter	Specification	Factory setting
Analog Outputs 1 and 2 Voltage Range (Volts DC)	0 – 5	0 – 5
Analog Output 2 Current Range (mA DC)	0 – 20, 4 – 20	–
Analog Output 2 Impedance for Current Mode (Ω)	150	–

ANALOG OUTPUT "1"

Connect the auxiliary device signal input to Terminal "15" and the common to Terminal "16".

ANALOG OUTPUT "2"

Connect the auxiliary device signal input to Terminal "17" and the common to Terminal "18".

Voltage Signal Output: Set both Jumpers J2 and J3 to the "VOLT" position (factory setting).

Current Signal Output: Set both Jumpers J2 and J3 to the "CUR" position.

A10. REMOTE SPEED POTENTIOMETER

A remote Speed Potentiometer (5 k Ω) can be used in lieu of the Keypad or the Built-In Speed Potentiometer on the drive to control motor speed. The potentiometer can be connected for Unidirectional Operation, Bidirectional Operation with center off, or Bidirectional Operation with Forward/Reverse Switches or Contacts.

UNIDIRECTIONAL OPERATION WITH 2-WIRE START/STOP USING ANALOG INPUT 1:

Connect the potentiometer to Terminals "9" (+5 Volts), "19" (Analog Input 1), and "16" (Common) (Terminals "8", "12", "14", "18", "22" can also be used for common). Connect the Start/Stop Switch or Contact to Terminal "5", which is factory set for N.O. Start ("0010"), and to any available common terminal ("8", "12", "14", "16", "18", "20", "22"). See Table 28, for drive programming. See Figure 36, on page 46, for connections.

Operation: When the Start/Stop Switch or Contact is closed, the drive will be in the Run Mode. Rotate the potentiometer clockwise to increase motor speed. Rotate the potentiometer counterclockwise to decrease motor speed. When the Start /Stop Switch or Contact is opened, the drive will be in the Stop Mode.

UNIDIRECTIONAL OPERATION WITH 2-WIRE START/STOP USING ANALOG INPUT 2:

Connect the potentiometer to Terminals "9" (+5 Volts), "21" (Analog Input 2), and "14" (Common) (Terminals "8", "12", "16", "18", "22" can also be used for Common). Connect the Start/Stop Switch or Contact to Terminal "5", which is factory set for N.O. Start ("0010"), and to any available common terminal ("8", "12", "14", "16", "18", "20", "22").

Operation: When the Start/Stop Switch or Contact is closed, the drive will be in the Run Mode. Rotate the potentiometer clockwise to increase motor speed. Rotate the potentiometer counterclockwise to decrease motor speed. When the Start /Stop Switch or Contact is opened, the drive will be in the Stop Mode.

TABLE 28
REMOTE UNIDIRECTIONAL SPEED POTENTIOMETER PROGRAMMING

Function No.	Code
1.00:Run/Stop-Forward/Reverse Control	0001: External Contacts
2.00:Frequency Control	0002: Analog Signal 1
7.04:Multi-Function Input Terminal 5	0010: N.O. Start*

*Factory setting.

FIGURE 36
REMOTE UNIDIRECTIONAL SPEED POTENTIOMETER CONNECTIONS

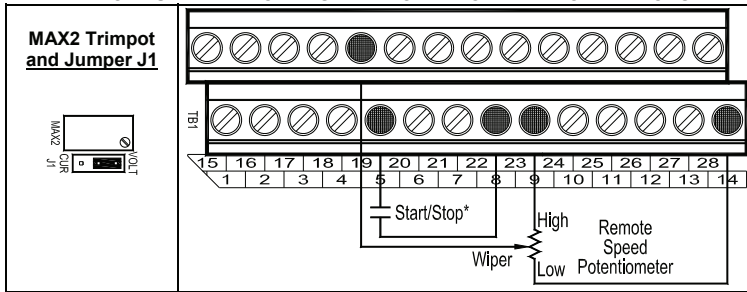

**Use a jumper, between Terminals "5" and "8", if a Start/Stop Switch or Contact is not required.*

BIDIRECTIONAL OPERATION WITH START/STOP (Use Analog Input "1" Only)

Connect the potentiometer to Terminals "9" (+5 Volts), "19" (Analog Input 1), and "10" (-5 Volts). Connect the Start/Stop Switch or Contact to Terminal "5", which is factory set for N.O. Start ("0010"), and to any available common terminal ("8", "12", "14", "16", "18", "20", "22"). See Table 29, for drive programming. See Figure 37, for connections.

Operation: Close the Start/Stop Switch or contact to start the drive. At 50% rotation, the potentiometer is set for zero speed. Rotating the potentiometer clockwise will increase motor frequency in the forward direction. Rotating the potentiometer counterclockwise will increase motor frequency in the reverse direction. Open the Start/Stop Switch or Contact to stop the drive.

TABLE 29
REMOTE BIDIRECTIONAL SPEED POTENTIOMETER PROGRAMMING

Function No.	Code
1.00:Run/Stop-Forward/Reverse Control	0001: External Contacts
2.00:Frequency Control	0002: Analog Signal 1
7.04:Multi-Function Input Terminal 5	0010: N.O. Start*
9.03:Analog Input 1 Type	0001: Bidirectional

**Factory setting.*

FIGURE 37
REMOTE BIDIRECTIONAL SPEED POTENTIOMETER CONNECTIONS

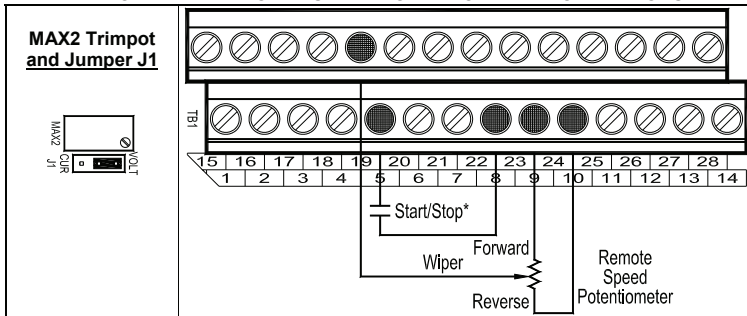

**Use a jumper, between Terminals "5" and "8", if a Start/Stop Switch or Contact is not required.*

BIDIRECTIONAL OPERATION WITH FORWARD/REVERSE:

Connect the potentiometer to Terminals "9" (+5 Volts), "19" (Analog Input 1), and "8" (Common) (Terminals "12", "14", "16", "18", "22" can also be used for Common). Connect the Forward Switch or Contact to a Multi-Function Input Terminal "1" – "7". Connect the Reverse Switch or Contact to a Multi-Function Input Terminal "1" – "7". Connect the Start (Jumper) to Terminal "5", which is factory set for N.O. Start ("0010"), and to any available common terminal ("8", "12", "14", "16", "18", "20", "22"). See Table 30, for drive programming. See Figure 38, for connections.

Operation: Close the Forward/Stop or Reverse/Stop Switch or Contact to put the drive in the Forward Run Mode or Reverse Run Mode. Rotate the potentiometer clockwise to increase motor speed. Rotate the potentiometer counterclockwise to decrease motor speed. Open the switch or contact to put the drive in the Stop Mode.

TABLE 30
REMOTE SPEED POTENTIOMETER WITH FORWARD/REVERSE PROGRAMMING

Function No.	Code
1.00:Run/Stop-Forward/Reverse Control	0001: External Contacts
2.00:Frequency Control	0002: Analog Signal 1
7.00:Multi-Function Input Terminal 1	0006: Forward/Stop Command
7.01:Multi-Function Input Terminal 2	0007: Reverse/Stop Command
7.04:Multi-Function Input Terminal 5	0010: N.O. Start*

*Factory setting.

FIGURE 38
REMOTE SPEED POTENTIOMETER WITH FORWARD/REVERSE CONNECTIONS

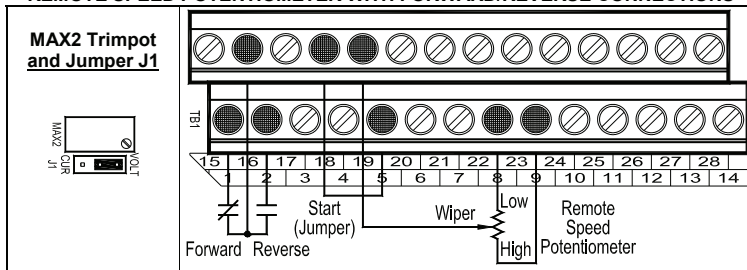

A11. MULTI-FUNCTION OUTPUT RELAYS

Two Multi-Function Output Relays are provided, which can be programmed for Run, Fault, Target Frequency, Frequency Threshold Level (> 8.04 – 8.05), Frequency Threshold Level (< 8.04 + 8.05), I²t or I-t Fault, Load Loss, External Fault, and Motor Overload. The maximum allowable contact load current is 2 Amps. See Table 31, on page 48, for drive programming. See Figure 39, on page 48, for connections.

Note: If the drive "stops", due to an External Fault Trip ("EF-t"), which indicates that a Multi-Function Input Terminal (Function Nos. 7.00 – 7.06 set to "0008") has closed, the Multi-Function Output Relay Contacts will change state (when Function No. 8.00 or 8.01 is set to "0007").

Multi-Function Output Relay 1 Contacts: Factory programmed to operate as a "Run" Relay (Function No. 8.00 set to "0000" (factory setting)). TB1 Terminal "23" is the Normally Open (N.O.) Contact, Terminal "24" is the Common, and Terminal "25" is the Normally Closed (N.C.) Contact.

Multi-Function Output Relay 2 Contacts: Factory programmed to operate as a "Fault" Relay (Function No. 8.01 set to "0001" (factory setting)). TB1 Terminal "26" is the Normally Open (N.O.) Contact, Terminal "27" is the Common, and Terminal "28" is the Normally Closed (N.C.) Contact.

TABLE 31
MULTI-FUNCTION OUTPUT RELAY CONTACTS PROGRAMMING

Function No.	Code
8.00: Multi-Function Output Relay 1	0000: Run
	0001: Fault
	0002: Target Frequency
	0003: Frequency Threshold Level (> 8.04 – 8.05)
	0004: Frequency Threshold Level (< 8.04 + 8.05)
	0005: I ² t or I*t Fault
	0006: Load Loss
	0007: External Fault
8.01: Multi-Function Output Relay 2	0000: Run
	0001: Fault
	0002: Target Frequency
	0003: Frequency Threshold Level (> 8.04 – 8.05)
	0004: Frequency Threshold Level (< 8.04 + 8.05)
	0005: I ² t or I*t Fault
	0006: Load Loss
	0007: External Fault
0008: Motor Overload	

FIGURE 39
MULTI-FUNCTION OUTPUT RELAYS CONTACT CONNECTIONS

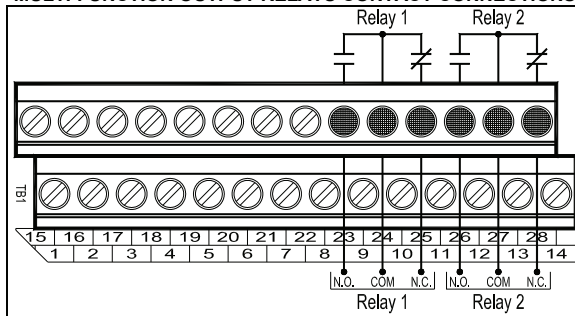

A12. MULTI-FUNCTION OPEN COLLECTOR OUTPUTS

Two Open Collector Outputs are provided, which can be programmed for Run, Fault, Target Frequency, Frequency Threshold Level (> 8.04 – 8.05), Frequency Threshold Level (< 8.04 + 8.05), I²t or I*t Fault, Load Loss, External Fault, and Motor Overload. See Table 32, on page 49, for drive programming. See Figure 40, on page 49, for connections. See Table 33, on page 49, for the Multi-Function Open Collector Output Electrical Ratings. See Figure 41, on page 49, for a typical application for the Open Collector Output.

Multi-Function Open Collector Output "1": Factory programmed to operate as a Target Frequency indicator (Function No. 8.02 set to "0002" (factory setting)). TB1 Terminal "11" is the Collector and Terminal "12" is the Emitter (internal circuit common).

Multi-Function Open Collector Output "2": Factory programmed to operate as a Frequency Threshold Level (< 8.04 + 8.05) indicator (Function No. 8.03 set to "0004" (factory setting)). TB1 Terminal "13" is the Collector and Terminal "14" is the Emitter (internal circuit common).

TABLE 32
MULTI-FUNCTION OPEN COLLECTOR OUTPUT PROGRAMMING

Function No.	Code
8.02: Multi-Function Open Collector Output 1	0000: Run
	0001: Fault
	0002: Target Frequency
	0003: Frequency Threshold Level (> 8.04 – 8.05)
	0004: Frequency Threshold Level (< 8.04 + 8.05)
	0005: I ² t or I-t Fault
	0006: Load Loss
	0007: External Fault
8.03: Multi-Function Open Collector Output 2	0000: Run
	0001: Fault
	0002: Target Frequency
	0003: Frequency Threshold Level (> 8.04 – 8.05)
	0004: Frequency Threshold Level (< 8.04 + 8.05)
	0005: I ² t or I-t Fault
	0006: Load Loss
	0007: External Fault
0008: Motor Overload	

FIGURE 40
MULTI-FUNCTION OPEN COLLECTORS OUTPUT CONNECTIONS

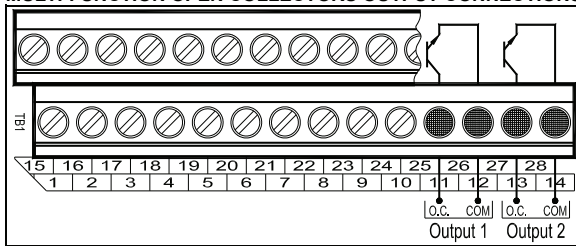
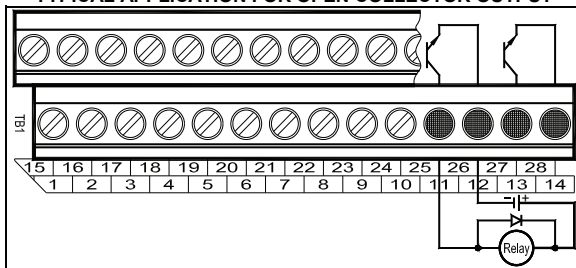

TABLE 33
MULTI-FUNCTION OPEN COLLECTOR OUTPUTS ELECTRICAL RATINGS

Parameter	Specification	Factory setting
Maximum Voltage (Volts DC)	24	–
Maximum Load Current (mA DC)	60	0 – 20
Minimum External Resistance (Ω)	400	–

FIGURE 41
TYPICAL APPLICATION FOR OPEN COLLECTOR OUTPUT



LIMITED WARRANTY

For a period of 18 months from the date of original purchase, KB Electronics, Inc. will repair or replace without charge, devices which our examination proves to be defective in material or workmanship. This warranty is valid if the unit has not been tampered with by unauthorized persons, misused, abused, or improperly installed and has been used in accordance with the instructions and/or ratings supplied. The foregoing is in lieu of any other warranty or guarantee, expressed or implied. KB Electronics, Inc. is not responsible for any expense, including installation and removal, inconvenience, or consequential damage, including injury to any person, caused by items of our manufacture or sale. Some states do not allow certain exclusions or limitations found in this warranty and therefore they may not apply to you. In any event, the total liability of KB Electronics, Inc. under any circumstance shall not exceed the full purchase price of this product. (rev 2/2000)

COPYRIGHT © 2008 KB Electronics, Inc.

All rights reserved. In accordance with the United States Copyright Act of 1976, no part of this publication may be reproduced in any form or by any means without permission in writing from KB Electronics, Inc. (8/2002)



KB Electronics, Inc.

12095 NW 39 Street, Coral Springs, FL 33065-2516

Phone: 954-346-4900; Fax: 954-346-3377, Outside Florida call Toll Free: 800-221-6570

e-mail: info@kbelectronics.com

www.kbelectronics.com

RECONDITIONING THE BUS CAPACITORS

If this drive has been in storage for over one year it is necessary to recondition the power supply bus capacitors. To recondition the bus capacitors, apply the AC Line, with the drive in the Stop Mode, for a minimum of one hour. Not following this procedure will cause the bus capacitors to fail.