

INSTALLATION AND OPERATION MANUAL

KBWK-23D

ADJUSTABLE FREQUENCY DRIVE FOR 3-PHASE AC MOTORS

NEMA 1 / IP 20 ENCLOSURE

MULTI-FUNCTION KEYPAD WITH 4-DIGIT LED DISPLAY

• Simplified Group Programming • 8 LED Status Indicators

Rated for 208 – 230 Volt 50 and 60 Hz
Subfractional thru 1/2 HP 3-Phase AC and 1-Phase PSC* Induction Motors

Operates from 115 and 208/230 Volt 50/60 Hz AC Line Input

Variable Speed / Soft Start
with Electronic Motor Overload Protection

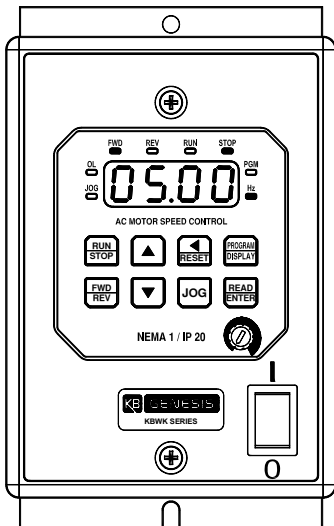

*Operation with
PSC motors requires
factory programming.



SEE
SAFETY WARNING
ON PAGE 4



Designed and
Assembled in USA

This Manual Covers Model KBWK-23D (Part No. 8860)

IMPORTANT

AC Line Input Voltage Setting: The drive is factory set for 208/230 Volt AC Line input. For 115 Volt AC Line input, see Section 10 on page 18.

Motor Frequency Setting: The drive is factory set for 60 Hz Motors. For 50 Hz Motors, see Section 6.1 on page 12.



The QR Code link
to this manual is also
located on the inside of
the drive cover.

Copyright © 2014
KB Electronics, Inc.
(see back cover)



Automation and Control

TABLE OF CONTENTS

Section	Page
1 SAFETY WARNING, CE INFORMATION, AND UL NOTICE.....	4
2 QUICK-START INSTRUCTIONS	5
3 FAMILIARIZING YOURSELF WITH THE DRIVE	6
4 ELECTRICAL RATINGS AND SPECIFICATIONS	9
5 INTRODUCTION	10
5.1 Standard Features	11
5.2 Performance Features.....	11
5.3 Selectable Jumper (J3)	11
5.4 Protection Features.....	12
5.5 Customization for OEMs.....	12
6 IMPORTANT PROGRAMMING INFORMATION	12
6.1 50 Hz Motors	12
6.2 Motor Current Setting	12
6.3 Reset Drive.....	12
7 IMPORTANT APPLICATION INFORMATION	13
7.1 Motor with External Fan Cooling	13
7.2 Electronic Motor Overload Protection.....	14
8 MOUNTING	14
9 REMOVING AND INSTALLING THE COVER	16
9.1 Removing the Cover.....	16
9.2 Installing the Cover	16
10 SETTING AC LINE INPUT VOLTAGE SELECTION JUMPER J3	18
11 RECONDITIONING THE BUS CAPACITORS.....	18
12 ELECTRICAL CONNECTIONS.....	18
12.1 AC Line Input and Ground.....	20
12.2 Motor and Ground	20
12.3 AC Line Input Fusing	20
13 HIGH VOLTAGE DIELECTRIC WITHSTAND TEST (HI-POT TEST)	20
14 DRIVE OPERATION.....	22
14.1 Start-Up Procedure.....	22
14.2 Keypad Description.....	22
14.3 Flow Charts for Important Programming Functions	23
15 4-DIGIT DISPLAY READOUT CODES	29
16 PROGRAMMABLE FUNCTIONS LIST.....	31
Appendix A: Keypad/Potentiometer Set Frequency Select (Shortcut)	36
Appendix B: Changing Operating Sense of the FWD/REV Key (Shortcut)	37
Appendix C: Reset and Memory Functions.....	38
Appendix D: Function Access Lockout and Passcode.....	39
LIMITED WARRANTY	Back Cover

TABLE OF CONTENTS (CONTINUED)

Table	Page
1 Descriptions of 4-Digit Display, LEDs, Keys, and Potentiometer	7
2 Electrical Ratings	9
3 General Performance Specifications	9
4 Terminal Block TB1 Wire and Tightening Torque Specifications	19
5 DC Hi-Pot Tester Setup Information	21
6 Digital Readout Codes	29

Figure	Page
1 Front Panel Layout	6
2 Drive Layout	8
3 Maximum Allowed Motor Torque vs. Speed	13
4 Open Ventilated Motor with External Cooling	13
5 Mechanical Specifications	15
6 Cover Positioned On Top of Case	17
7 AC Line Input Voltage Selection Jumper J3	18
8 AC Line Input, Motor, and Ground Connections	19
9 Typical Hi-Pot Test Setup	21
10 Programming Motor Nameplate Current (Flow Chart)	23
11 Programming Set Frequency (Flow Chart)	24
12 Programming Rated Motor Frequency (Flow Chart)	24
13 Programming Accel Time (Flow Chart)	25
14 Programming Display for Custom Units (Flow Chart)	26
15 Programming Display (Flow Chart)	27
16 Adding Parameters to Basic Display (Flow Chart)	27
17 Programming Function Access Lockout and Setting A Passcode (Flow Chart)	28
18 Function No. Description	31

ITEMS INCLUDED IN THIS PACKAGE

Description	Part No.
KBWK Drive	8860
Installation and Operation Manual	A40197
Hardware Bag: Jumper J3 (to Set the Drive for 115 Volt AC Line Input), Extra 6-32 X 1-1/4" Cover Screw, and two Universal Bushings.	F36875
Mounting Template	A42326
Warranty Registration Card	A40101

SAFETY WARNING

Definition of Safety Warning Symbols



Electrical Hazard Warning Symbol: Failure to observe this warning could result in electrical shock or electrocution.



Operational Hazard Warning Symbol: Failure to observe this warning could result in serious injury or death.



This product should be installed and serviced by a qualified technician, electrician, or electrical maintenance person familiar with its operation and the hazards involved. Proper installation, which includes electrical connections, fusing or other current protection, and grounding, can reduce the chance of electrical shocks, and/or fires, in this product or products used with this product, such as electric motors, switches, coils, solenoids, and/or relays. Do not use this drive in an explosion-proof application. Eye protection must be worn and insulated adjustment tools must be used when working with drive under power. This product is constructed of materials (plastics, metals, carbon, silicon, etc.) which may be a potential hazard. Proper shielding, grounding, and filtering of this product can reduce the emission of radio frequency interference (RFI) which may adversely affect sensitive electronic equipment. It is the responsibility of the equipment manufacturer and individual installer to supply this Safety Warning to the ultimate end user of this product. (SW 1/2006)

The drive contains electronic Start/Stop circuits, which can be used to start and stop the drive. However, these circuits are never to be used as safety disconnects since they are not fail-safe. Use only the AC Line for this purpose.

Be sure to read and follow all instructions carefully. Fire and/or electrocution can result due to improper use of this product.

CE INFORMATION



This product complies with all CE directives pertinent at the time of manufacture. Contact our Sales Department for Declaration of Conformity. Installation of a CE approved RFI filter is required. Additional shielded cable and/or AC Line cables may be required.

Note: *In order for this drive to meet CE requirements, a separate CE approved filter must be installed.*

UL NOTICE

115 Volt Drives: Suitable for use on a circuit capable of delivering not more than 5 kA RMS symmetrical Amperes. 115 Volts maximum. Use copper conductors rated 75 °C. Suitable for operation in a maximum surrounding air temperature of 40 °C.

230 Volt Drives: Suitable for use on a circuit capable of delivering not more than 5 kA RMS symmetrical Amperes. 230 Volts maximum. Use copper conductors rated 75 °C. Suitable for operation in a maximum surrounding air temperature of 40 °C.

2 QUICK-START INSTRUCTIONS

2.1 REMOVE THE COVER

Remove the cover to setup and wire the drive. See Section 9.1 on page 16.

2.2 MOUNT THE DRIVE

See Section 8 on pages 14 and 15.

2.3 AC LINE INPUT SELECTION

The drive is factory set for 208/230 Volt AC Line input (Jumper J3 not installed). Install the supplied jumper to set the drive for 115 Volt AC Line input. See Section 10 on page 18. **Note:** *The drive will operate 230 Volts AC motors with 115 Volt AC line input.*

2.4 AC LINE INPUT, MOTOR, AND GROUND CONNECTIONS

At Terminal Block TB1, wire the AC Line input to "L1 and "L2"; the ground wire(s) to "GND"; and the motor to "U", "V", and "W". See Section 12 on pages 18 – 20.

2.5 INSTALL THE COVER

After the drive has been setup, mounted, and wired, install the cover. See Section 9.2 on page 16.

2.6 GFCI OPERATION

Allows the drive to operate with Ground Fault Circuit Interruption circuit breakers and outlets. Use Function 0.04 to program for GFCI operation. (May increase audible motor noise.)

2.7 SELECTING SET FREQUENCY ADJUSTMENT METHOD (SHORTCUT)

The Keypad/Potentiometer shortcut allows the selection of the source for adjusting the Set Frequency without requiring reprogramming the drive. The Keypad is factory programmed as the default for adjusting the Set Frequency. To use the Built-In Potentiometer to adjust Set Frequency, press both Up and Down Keys simultaneously for 4 seconds. To switch back to using the Keypad to adjust Set Frequency, press both Up and Down Keys simultaneously for 4 seconds. See Appendix A on page 36.

2.8 CHANGING OPERATING SENSE OF THE FWD/REV KEY (SHORTCUT)

For applications that require changing motor direction, the sense of the FWD/REV Key can be changed, without requiring reprogramming the drive or reversing any two motor leads. Press and hold the FWD/REV Key for 5 seconds (drive must be in Stop Mode). The forward direction will now be "reverse" and the reverse direction will now be "forward". See Appendix B on page 37.

2.9 MOTOR FREQUENCY SELECTION

The drive is factory set to operate 60 Hz motors (Function 0.00 set to "0000"). For 50 Hz motors, set Function 0.00 to "0001". See Flow Chart (Figure 12) on page 24.

3 FAMILIARIZING YOURSELF WITH THE DRIVE

The drive has a 4-Digit LED Display, 8 Status LEDs, a Multi-Function Keypad, a built-in potentiometer, and a factory installed On/Off AC Line Switch. See Figure 1, below, and Table 1 on page 7. Remove the cover to access Jumper J3 terminals (AC Line Input Voltage Selection) and Terminal Block TB1 (AC Line input, Motor, and Ground connections). See Figure 2 on page 8.

- **Mounting:** Section 8 on pages 14 and 15.
- **Removing and Installing the Cover:** Section 9 on pages 16 and 17.
- **AC Line Input Voltage Selection Jumper J3:** Section 10 on page 18 and 19.
- **Electrical Connections:** Section 12 on pages 18 – 20.
- **Drive Operation:** Section 14 on pages 22 – 28.

FIGURE 1
FRONT PANEL LAYOUT (SEE TABLE 1 ON PAGE 7 FOR DESCRIPTIONS)

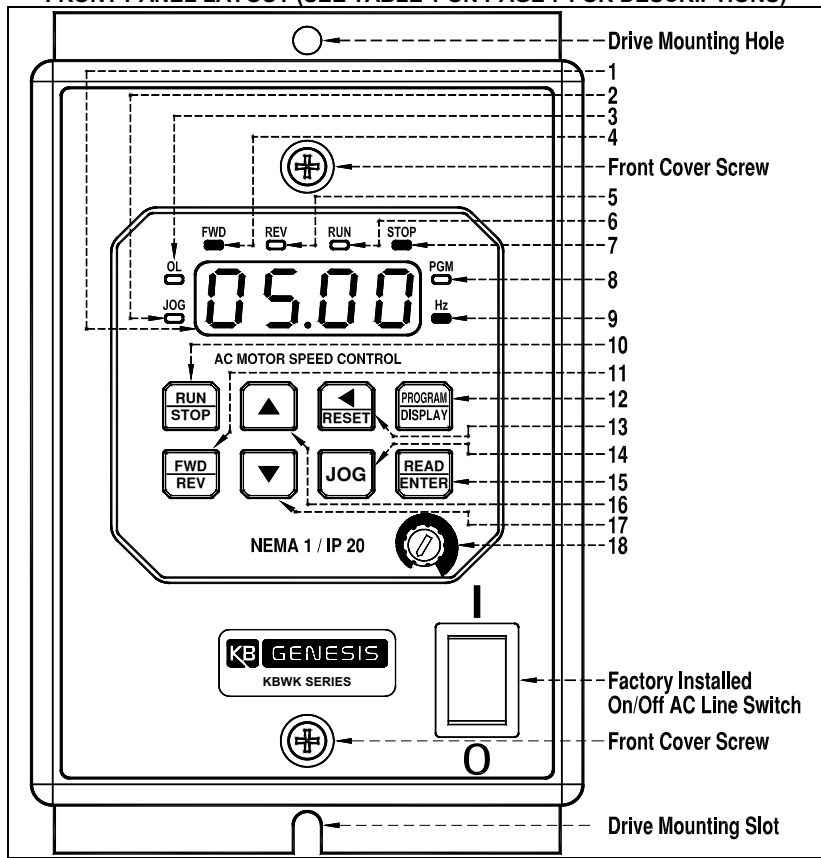

















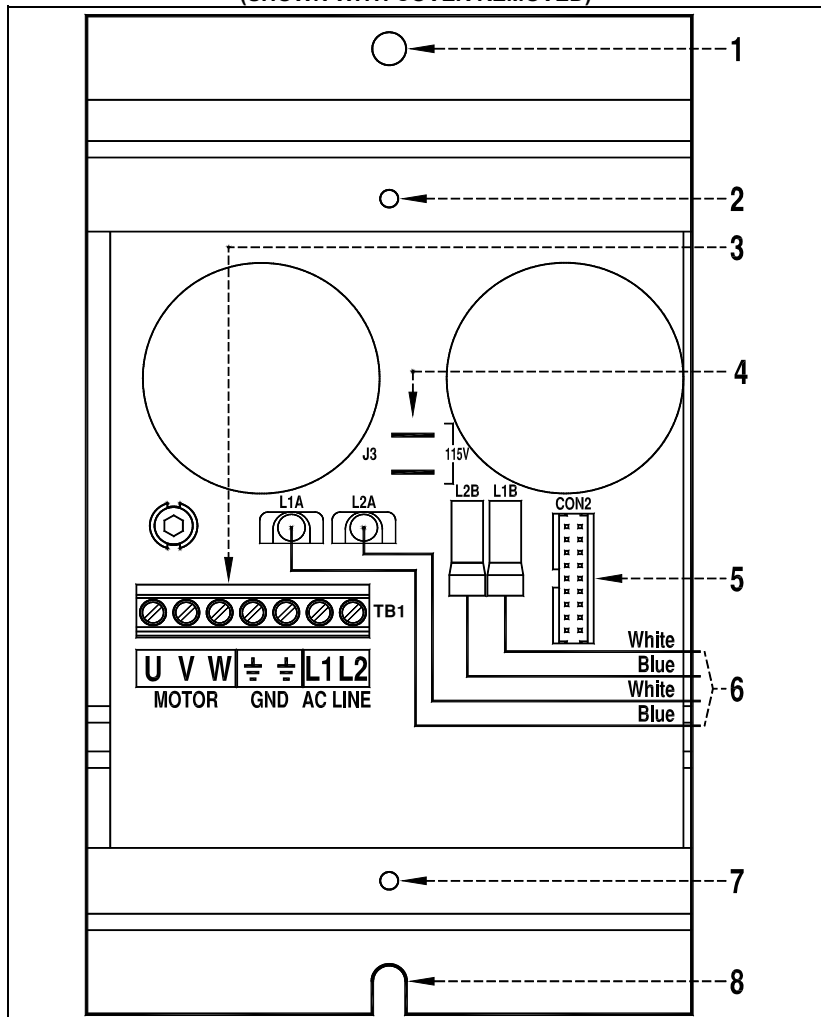

TABLE 1
DESCRIPTIONS OF 4-DIGIT DISPLAY, LEDs, KEYS, AND POTENTIOMETER

No.	Feature	Description
1		4-Digit Display: Provides readout of drive status, functions, and faults.
2		JOG LED: Indicates that the drive is in Jog Mode.
3		OL LED: Indicates that the drive is in Overload.
4		FWD LED: Indicates that the drive is set for Forward Direction.
5		REV LED: Indicates that the drive is set for Reverse Direction.
6		RUN LED: Indicates that the drive is in the Run Mode.
7		STOP LED: Indicates that the drive is in Stop Mode.
8		PGM LED: Indicates that the drive is in Program Mode.
9		Hz LED: Indicates that the display is set to show Drive Output Frequency (in Hz).
10		RUN / STOP Key: Starts and stops the drive.
11		FWD/REV Key: Changes motor direction.
12		PROGRAM / DISPLAY Key: Puts the drive into Program Mode or Display Mode. If pressed while Set Frequency is displayed, the previously entered Function Number will be shown. If pressed while Function Number is displayed, the Set Frequency will be shown. When more than one display function is enabled, the key is used to toggle between displays.
13		Left Shift / Reset Key: Moves the changeable digit or Resets the drive after a fault has cleared.
14		JOG Key: Provides a fixed preset speed.
15		READ / ENTER Key: Reads or Enters a Function Value or Code Setting.
16		Up Key:* Increases Output Frequency, Set Frequency, Function Number Value, and Code setting. Also used as shortcut key.*
17		Down Key:* Decreases Output Frequency, Set Frequency, Function Number Value, and Code setting. Also used as shortcut key.*
18		Potentiometer:* Sets the Drive Output Frequency in lieu of the Keypad. To change the Keypad for Potentiometer Operation, set Function 2.00 to "0001".

**Adjustment of Set Frequency can be switched between the built-in potentiometer and the keypad by pressing both Up and Down Keys simultaneously for 4 seconds. See Appendix A on page 36.*

FIGURE 2
DRIVE LAYOUT (SEE DESCRIPTIONS BELOW)
(SHOWN WITH COVER REMOVED)



1. Drive mounting hole. 2. Cover mounting hole. 3. TB1 for AC Line Input, Motor, and Ground connections. See Sections 12.1 and 12.2 on page 20. 4. J3 for AC Line Input voltage selection (factory set for 208/230 Volt AC Line Input). See Section 10 on page 18. 5. CON2 for Keypad interface connector. 6. To factory installed On/Off AC Line Switch. 7. Cover mounting Hole. 8. Drive mounting slot.

4 ELECTRICAL RATINGS AND SPECIFICATIONS

**TABLE 2
ELECTRICAL RATINGS**

Maximum Horsepower (HP (kW))	AC Line Input			Fuse or Circuit Breaker Rating (Amps)	Output		Net Wt.	
	Volts AC (50/60 Hz)	Phase (Ø)	Maximum Current (Amps AC)		Maximum Continuous Load Current (RMS Amps)	Maximum Voltage (Volts AC)	lbs	kg
0.5 (0.37)	115	1	8.8	15	2.2	230	1.72	0.78
	208/230	1	6.0	10	2.4			

**TABLE 3
GENERAL PERFORMANCE SPECIFICATIONS**

Description	Specification	Factory Setting
115 Volt AC Line Input Voltage Operating Range (Volts AC)	115 (±15%)	—
208/230 Volt AC Line Input Voltage Operating Range (Volts AC)	208 (-15%) / 230 (+15%)	208/230
Maximum Load (% Current Overload for 2 Minutes)	150	—
Switching Frequency (Function 3.17) (kHz)	8, 10, 12	8
Output Frequency Resolution (Hz)	0.06	—
Minimum Operating Frequency at Motor (Hz)	1	—
Acceleration Time (Function 3.03) (Seconds)	0.1 – 180.0	1.5
Deceleration Time (Function 3.04) (Seconds)	0.3 – 180.0	1.5
Speed Range (Ratio)	60:1	—
Speed Regulation (30:1 Speed Range, 0 – Full Load) (% Base Speed) ¹	2.5	—
Overload Protector Trip Time for Stalled Motor (Seconds)	6	—
AC Line Input Undervoltage/Overvoltage Trip Points For 115 Volt AC Line (±5%) (Volts AC) ²	76 – 141	—
AC Line Input Undervoltage/Overvoltage Trip Points for 208/230 Volt AC Line (±5%) (Volts AC) ²	151 – 282	—
Operating Temperature Range (°C / °F)	0 – 40 / 32 – 104	—
Operating Humidity Range (% Relative, Non-Condensing)	0 – 95	—
Storage Temperature (°C / °F)	-25 – +85 / -13 – +185	—

Notes: 1. Dependent on motor performance. 2. Do not operate the drive outside the specified AC line input voltage operating range.

5 INTRODUCTION

Thank you for purchasing the KBWK Digital AC Drive. KB Electronics, Inc. is committed to providing total customer satisfaction by providing quality products that are easy to install and operate.

The KBWK drive is housed in NEMA 1 / IP 20 enclosure. It is designed to operate subfractional through 1/2 HP 208 – 230 Volt 50 and 60 Hz 3-phase AC and PSC induction motors.¹ Flux Vector Control provides high torque, low noise, and excellent load regulation over a wide speed range. Adjustable linear acceleration and deceleration make the drive suitable for soft-start applications.

Due to its user-friendly design and simple to use and understand instruction manual, the KBWK is easy to install and operate. Setting the drive to specific applications is accomplished using the Multi-Function Keypad, which provides easy operation and programming of the drive. To facilitate programming, all similar functions are presented in common groups to allow for common sense programming (CSP).

The 4-Digit Display provides readout of drive operation, programming functions, and displays Output Frequency, Motor RPM, Output Current, Output Voltage, Bus Voltage, Function Codes and Values, Fault Codes, and Custom Units. The 8 LEDs provide indication of the drive's operational status. The on-board memory can store a user-defined custom program.

Main Features: Adjustable RMS Current Limit and I²t Motor Overload Protection.² Flux Vector Control with Static Auto-Tune provides high torque and excellent load regulation over a wide speed range. Power Start™ delivers over 200% motor torque to ensure startup of high frictional loads and programmable Injection Braking provides rapid motor stop. Electronic Inrush Current Limit (EICL™) eliminates harmful AC Line inrush current, allowing the drive to be AC Line switched. The drive is suitable for machine or variable torque (HVAC) applications. A terminal block is provided to facilitate AC line input, motor, and ground connections. A selectable jumper (supplied) allows the drive to be set for 115 or 208/230 Volt AC Line input. The drive includes a built-in potentiometer and an illuminated On/Off AC Line Switch. The drive also contains a programmable passcode feature, which can be used to prevent tampering or unauthorized changes to programmed functions and settings. Adjustment of Set Frequency can be switched, without requiring programming, between the built-in potentiometer and the keypad using shortcut keys.

Notes: 1. PSC motor operation requires OEM software – contact our Sales Department. 2. UL approved as an electronic overload protector for motors.

5.1 STANDARD FEATURES

- **Simplified Programming:** Programmable functions are organized into easy-to-understand intuitive groups (common sense programming (CSP)). Factory programming available.
- **Current and Torque Limit:** Current and torque limiting in motoring and braking quadrants. Automatic extending of Accel and Decel eliminates nuisance tripping caused by rapid acceleration and deceleration of high inertial loads. Spin Start operation catches a spinning load and allows a smooth return to the set motor speed.
- **4-Digit Display and 8 LEDs:** Provide readout of programming functions and indication of the drive's operational status.
- **Easy-to-Use Multi-Function Keypad:** Facilitates programming the drive.
- **Dual Voltage AC Line Input Operation:** The drive operates from 115 and 208/230 Volt 50/60 Hz AC Line input. See Section 10 on page 18.
- **Built-In Potentiometer:** Adjusts set motor speed in lieu of the keypad.
- **Factory Installed On/Off AC Line Switch:** The switch illuminates when power is applied to the drive and the switch is in the on position.
- **GFCI OPERATION:** Tripless operation with GFCI software allows the equipment to operate with Ground Fault Circuit Interruption circuit breakers or outlets. (May increase audible motor noise.) See Function 0.04.
- **Passcode:** Programmable passcode feature can be used to prevent tampering or unauthorized changes to programmed functions and settings.
- **Custom Programming for OEM Applications:** Provides out-of-the-box operation.

5.2 PERFORMANCE FEATURES

- **High Performance Sensorless Flux Vector Control with Static Auto Tuning:** Provides excellent speed regulation with high torque loads throughout the entire speed range. Auto energy savings at light loads. Smooth motor torque.
- **Library of Advanced Algorithms:** Custom programming and PLC functions for OEM applications.
- **Power Start™:** Provides more than 200% starting torque, which ensures startup of high frictional loads.
- **Speed Range:** Full torque control over a 60:1 speed range.

5.3 SELECTABLE JUMPER (J3)

- **J3 (115V):** The drive is factory set for 230 Volt AC Line input (J3 not installed). For 115 Volt AC Line input, install Jumper J3 (supplied). See Section 10 on page 18.

5.4 PROTECTION FEATURES

- **Motor Overload (I^2t) with RMS Current Limit:** Provides motor overload protection which prevents motor burnout and eliminates nuisance trips. UL approved as an electronic overload protector for motors. See Section 6.2 below.
- **Electronic Inrush Current Limit (EICL™):** Eliminates harmful inrush AC Line current during startup and allows rapid start with AC Line.
- **Short Circuit:** Shuts down the drive if a short circuit occurs at the motor (phase-to-phase).
- **Regeneration:** Eliminates nuisance tripping due to bus overvoltage caused by rapid deceleration of high inertial loads.
- **Undervoltage and Overvoltage:** Shuts down the drive if the AC Line input voltage goes below or above the operating range.
- **MOV Input Transient Suppression:** Protects the drive components against damaging voltage spikes on the AC line.
- **Microcontroller Self Monitoring and Auto-Reboot.**

5.5 CUSTOMIZATION FOR OEMs

- **Custom Software:** The drive is preset and ready to use "out-of-the-box". Custom front panels are also available. The drive can be factory programmed for applications that require special switching, timing, PLC functions, and GFCI operation. Contact our Sales Department.

6 IMPORTANT PROGRAMMING INFORMATION

6.1 50 Hz MOTORS

This drive is factory programmed to operate 60 Hz motors. For 50 Hz motors, set Function 0.00 to "0001" (50 Hz). See Flow Chart (Figure 12) on page 24.

6.2 MOTOR CURRENT SETTING

The motor current is factory set to the maximum drive rating, as shown in Table 2 on page 9. In order for the Motor Overload Protection to operate properly, the drive must be reprogrammed to the actual Motor Nameplate Current (see Function 0.01). Do not exceed the drive's maximum current rating. See Flow Chart (Figure 10) on page 23.

6.3 RESET DRIVE

For Factory Settings, set Function 5.06 to "1111". For OEM Custom Program, set Function 5.06 to "1010". For User Custom Program set Function 5.06 to "1100". See Appendix C on pages 38 and 39.

7 IMPORTANT APPLICATION INFORMATION

7.1 MOTOR WITH EXTERNAL FAN COOLING

Most totally enclosed fan-cooled (TEFC) and open ventilated 3-phase AC induction motors will overheat if used beyond a limited speed range at full torque. Therefore, it is necessary to reduce motor load as speed is decreased.

Note: Some fan-cooled motors can be used over a wider speed range. Consult the motor manufacturer for details.

Inverter duty and most Totally Enclosed Non-Ventilated (TENV) motors can provide full rated torque over an extended speed range without overheating. See Figure 3.

 **It is recommended that the drive be used with Inverter Duty or TENV motors.**

 **WARNING!** Some motors have low speed characteristics, which cause overheating and winding failure under light load or no load conditions. If the motor is operated in this manner for an extended period of time, it is recommended that the unloaded motor current be checked from 2 – 15 Hz (60 – 450 RPM) to ensure motor current does not exceed the nameplate rating. If the motor current exceeds the nameplate rating, the Boost Value may have to be decreased (see Function 3.16). **Do not use motor if the motor current exceeds the nameplate rating.**

If external cooling is provided, open ventilated motors can also achieve an extended speed range at full rated torque. A fan or blower with a minimum of 100 CFM per HP is recommended. Mount the fan or blower so the motor is surrounded by the airflow. See Figure 4.

FIGURE 3
MAXIMUM ALLOWED
MOTOR TORQUE VS. SPEED

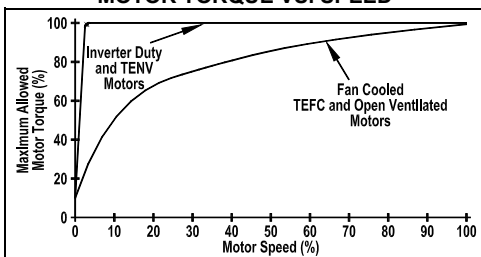
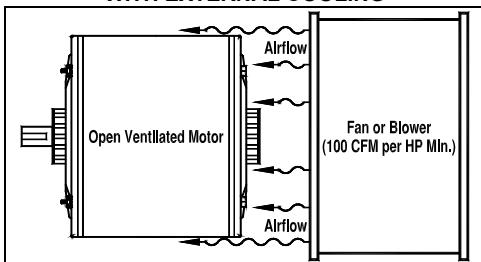

FIGURE 4
OPEN VENTILATED MOTOR
WITH EXTERNAL COOLING



7.2 ELECTRONIC MOTOR OVERLOAD PROTECTION

The drive contains Modified I^2t Overload Protection (UL approved as an overload protector for motors). Part of this function consists of a Current Limit (CL) circuit, which limits the drive current to a preset level of 160% of the Motor Nameplate Rated Current setting. **The factory setting for Motor Nameplate Current (Function 0.01) is the drive rated current, as shown in Table 2 on page 9, which must be set to the actual motor nameplate current (see Important Programming Information (Section 6 on page 12)).**

Standard I^2t is undesirable because it causes nuisance tripping. It allows a very high motor current to develop, causing the drive to trip after a short period of time. KB's RMS Current Limit Circuit avoids this nuisance tripping while providing maximum motor protection. It limits the maximum current the motor can draw to 160%.

If the motor is overloaded to 120% of the Motor Nameplate Rated Current, the I^2t Timer starts. If the motor continues to be overloaded at the 120% level, the timer will shut down the drive after 30 minutes. If the motor is overloaded to 160% of full load, the drive will trip in 6 seconds.

8 MOUNTING

Use the supplied mounting template to facilitate locating the holes to mount the drive. It is recommended that the drive be mounted vertically on a flat surface with adequate ventilation. Leave enough room below the drive to allow for AC Line, motor connections, and any other connections that are required. Care should be taken to avoid extreme hazardous locations where physical damage can occur. When mounting the drive in an enclosure, the enclosure should be large enough to allow proper heat dissipation so that the ambient temperature does not exceed 40 °C (104 °F) at full rating. See Figure 5 on page 15.



WARNING! DO NOT USE THIS DRIVE IN AN EXPLOSIVE ENVIRONMENT. AN EXPLOSION CAN CAUSE SERIOUS OR FATAL INJURY. THIS DRIVE IS NOT EXPLOSION PROOF.

FIGURE 5
MECHANICAL SPECIFICATIONS (INCHES/mm)

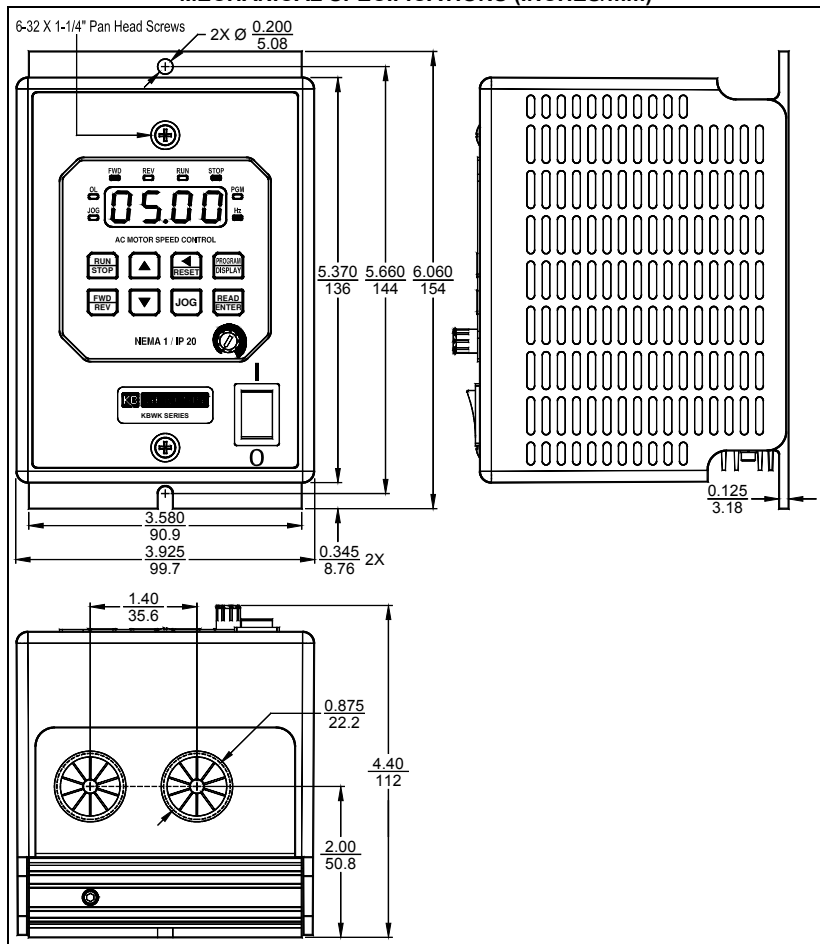

9 REMOVING AND INSTALLING THE COVER

The cover must be removed to set up the drive. See Section 9.1 for instructions on removing the cover. See Section 9.2 for instructions on installing the cover.

- **AC Line Input Voltage Selection Jumper J3 Setting:** See Section 10 on page 18.
- **AC Line, Motor, and Ground Connections:** See Section 12 on pages 18 – 20.



WARNING! Disconnect the main power before removing or installing the cover.



WARNING! After disconnecting the main power to the drive, wait at least 30 seconds before removing the cover.



WARNING! To prevent accidental contact with high voltage, it is required that the cover be properly installed onto the drive after all wiring and setup is complete. It offers protection against electric shock which limits the potential liability to the equipment manufacturer and installer.

9.1 REMOVING THE COVER

Remove the two screws on the cover and slide it off the drive's base. Be careful not to separate the wires from the drive to the cover's On/Off AC Line Switch and the Keypad's interface ribbon cable.

To facilitate wiring the drive, place the cover on top of the case, as shown in Figure 6 on page 17.

9.2 INSTALLING THE COVER

After setting up the drive, install the cover. Be sure that the wires remain inside the drive so they do not get crimped while it is being installed. Replace the two cover screws. The screws should be tightened to 5 in-lbs (5.76 kg-cm) – do not overtighten.

FIGURE 6
COVER POSITIONED ON TOP OF CASE
(All Wires Omitted for Clarity)

(Use Heat Sink Fins, As Shown, to Support Cover for Easy Access to Terminals)

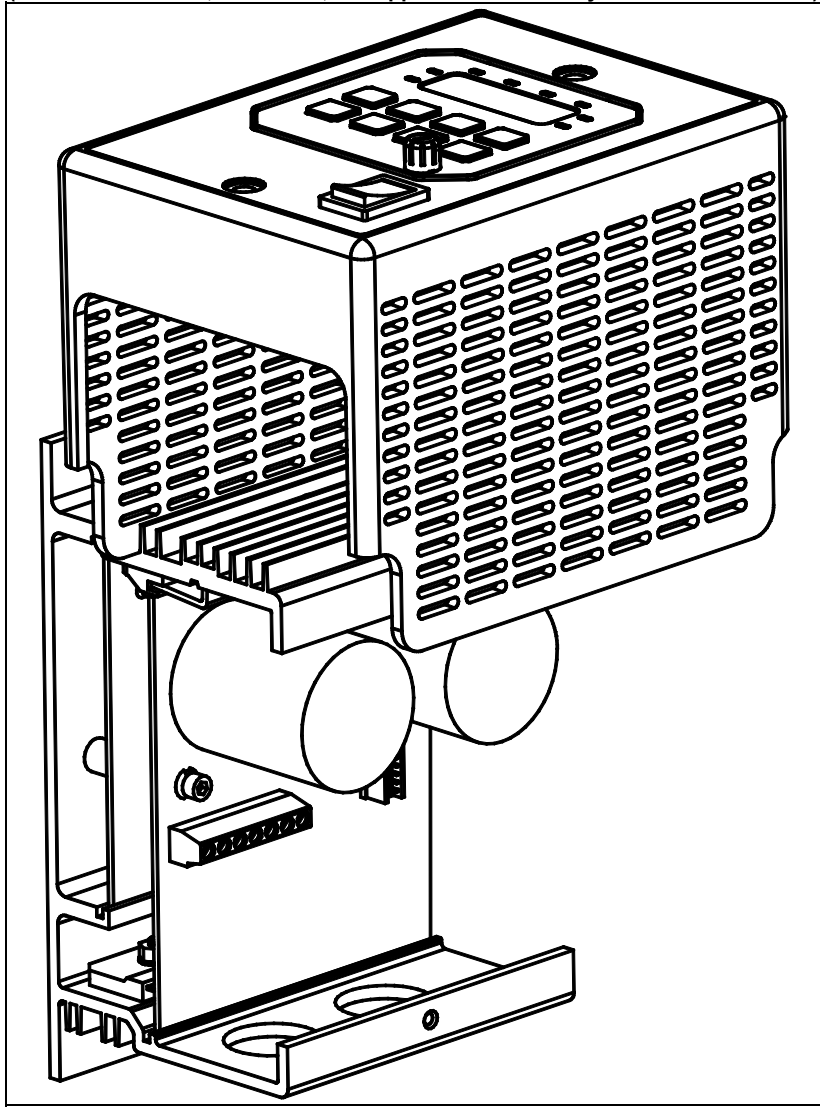

10 SETTING AC LINE INPUT VOLTAGE SELECTION JUMPER J3

The drive is factory set for 208/230 Volt AC Line input (Jumper J3 not installed). For 115 Volt AC line input, install Jumper J3 (supplied) onto the two PC board quick-connect terminals. See Figure 7 below and Figure 8 on page 19.

Note: The drive will operate 230 Volts AC motors with 115 Volt AC line input.

FIGURE 7
AC LINE INPUT VOLTAGE SELECTION JUMPER J3

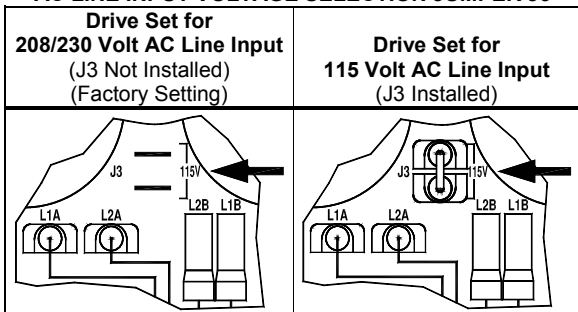

11 RECONDITIONING THE BUS CAPACITORS

If this drive has been in storage for over one year it is necessary to recondition the power supply bus capacitors. To recondition the bus capacitors, apply the AC Line, with the drive in the Stop Mode, for a minimum of one hour. Not following this procedure will cause the bus capacitors to fail.

12 ELECTRICAL CONNECTIONS

The drive is designed with a PC board mounted terminal block to facilitate wiring of the AC Line input, Motor, and Ground connections, as shown in Figure 8 on page 19. The removable cover allows access to Terminal Block TB1 and Jumper J3 terminals for wiring and setting up the drive. For Terminal Block TB1 Wire and Tightening Torque Specifications, see Table 4 on page 19.

The drive is designed with two 0.875" (22.2 mm) holes for standard 3/4" fittings for wiring the AC Line input, motor and ground.

Note: Wire the control in accordance with the National Electrical Code requirements and other local codes that may apply to the application.



WARNING! HIGH VOLTAGE! Read Safety Warning on page 4, before using the drive. Disconnect the main power before making connections to the drive. To avoid electric shock, be sure to properly ground the drive.

Application Notes: 1. To avoid erratic operation, do not bundle AC Line input and motor wires with each other. Also, do not bundle motor wires from multiple drives in the same conduit. 2. Be sure to properly fuse each AC Line conductor that is not at ground potential. Do not fuse neutral or grounded conductors. For fuse or circuit breaker selection, see Table 2 on page 9. Also see Section 12.3 on page 20.

TABLE 4
TERMINAL BLOCK TB1 WIRE AND TIGHTENING TORQUE SPECIFICATIONS

Copper Wire Size Range (Solid or Stranded*)		Wire Strip Length		Tightening Torque Range	
AWG	mm ²	in	mm	in-lbs	kg-cm
30 – 14	0.05 – 2.08	0.25	6	4.4 – 5.3	5.1 – 6.1

*If using stranded wire, be sure that all strands are contained in the terminal block housing.

FIGURE 8
AC LINE INPUT, MOTOR, AND GROUND CONNECTIONS

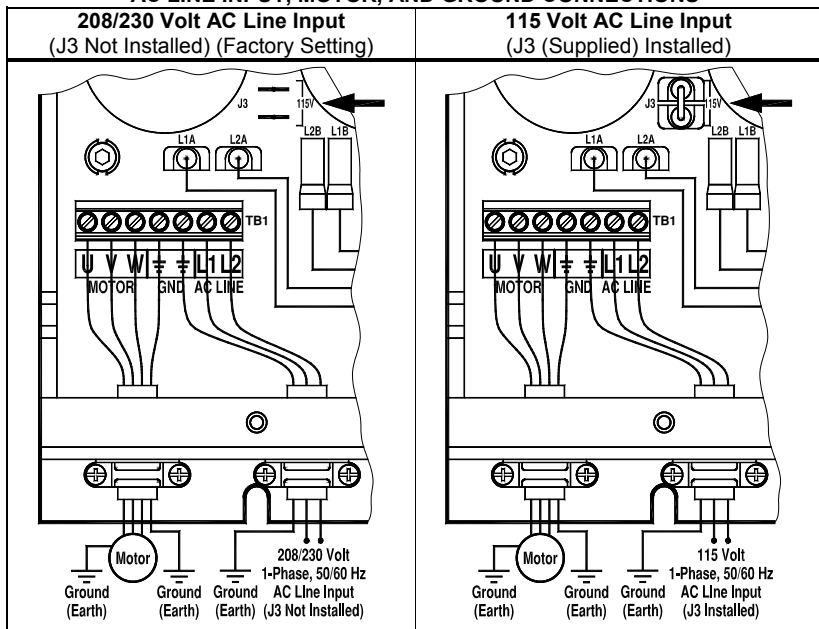

12.1 AC LINE INPUT AND GROUND

Connect the 1-phase AC line input to TB1 Terminals "L1" and "L2". Connect the Ground (earth) to TB1 Terminal "GND". See Figure 8 on page 19.

IMPORTANT NOTE: *The actual AC Line Input voltage must correspond to the setting of Jumper J3. For 208/230 Volt AC Line Input, be sure that Jumper J3 is not installed. For 115 Volt AC Line input, install Jumper J3 (supplied). Applying 230 Volts to the drive set for 115 Volt AC Line input will cause catastrophic failure. See Section 10 on page 18.*

12.2 MOTOR AND GROUND

Connect the Motor to TB1 Terminals "U", "V", and "W". Connect the Ground (earth) to TB1 Terminal "GND". See Figure 8 on page 19. Motor cable length should not exceed 100 feet (30 m) – special reactors may be required – consult our Sales Department.

Be sure that the Current Limit is set to the actual motor nameplate current rating. See Function 0.01. Do not exceed the drive's maximum current rating.

Note: *If the motor does not rotate in accordance with the FWD/REV Key, either:*

- 1. Press and hold the FWD/REV Key for 5 seconds to change its operating sense.*
- 2. Use Function 1.01 to change the operating sense of the FWD/REV Key.*
- 3. Reverse any two motor leads (AC Line must be disconnected).*

12.3 AC LINE INPUT FUSING

The drive does not contain AC Line fuses. For the recommended fuse or circuit breaker rating, see Table 2 on page 9. Do not fuse motor leads. Most electrical codes require that each ungrounded conductor contain circuit protection. Do not fuse neutral or ground connections. It is recommended to install a fuse (Littelfuse 326, Buss ABC, or equivalent) or a circuit breaker (Square D QOU or equivalent) in series with each ungrounded conductor.

13 HIGH VOLTAGE DIELECTRIC WITHSTAND TEST (HI-POT TEST)

The drive has passed factory hi-pot testing in accordance with UL requirements. Testing agencies such as UL, CSA, etc., usually require that equipment undergo an AC Hi-Pot Test. In order to prevent catastrophic damage to the drive, which has been installed in the equipment, the following procedure is recommended. A typical Hi-Pot Test Setup is shown in Figure 9 on page 21.

TABLE 5
DC HI-POT TESTER SETUP INFORMATION

Input Line Voltage (Volts AC)	Hi-Pot Test Voltage (Volts AC)
115	1800
208/230	2100

Hi-Pot Test Voltage = (Line Voltage X 2) + 1000

EQUIPMENT

A ramp-up type AC Hi-Pot Tester must be used. A suggested Hi-Pot Tester is Slaughter Model 2550, or equivalent.

PROCEDURE



Warning! All equipment AC line inputs must be disconnected from the AC power before performing the Hi-Pot Test.

Note: If the Hi-Pot Tester does not have automatic ramping, then the hi-pot output must be manually increased to the test voltage and then manually reduced to zero.

1. Set the Hi-pot Tester to the appropriate voltage, as shown in Table 5 above.
2. Connect all equipment AC power input lines together and connect them to the H.V. lead of the Hi-Pot Tester.
3. Connect the RETURN of the Hi-Pot Tester to the frame on which the drive and other auxiliary equipment are mounted. The Hi-Pot Tester must have an automatic ramp-up to the test voltage and an automatic ramp-down to zero voltage.

CAUTION! Instantly applying the hi-pot voltage will cause irreversible damage to the drive, which will void the warranty.

FIGURE 9
TYPICAL HI-POT TEST SETUP

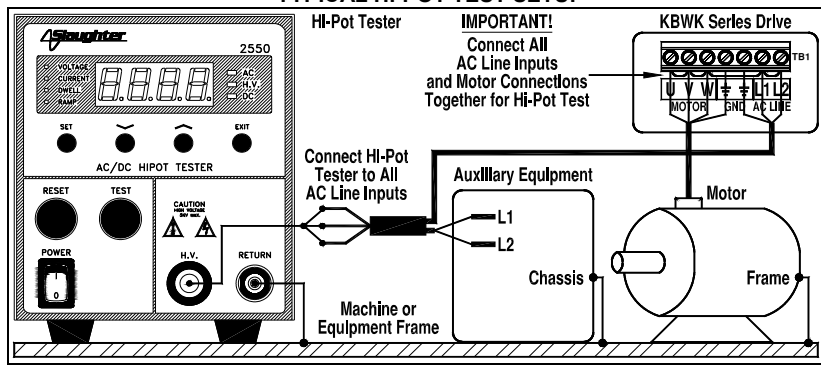

14 DRIVE OPERATION

Before operating the drive, read Section 14.2 for a description of the Keypad. See Figure 1 on page 6, for the keypad layout. The 4-digit display can indicate various functions of the drive: Set Frequency, Motor RPM, Output Current and Voltage, Custom Units, Function Numbers, Function Codes or Values, and Fault Codes. See Section 15 on pages 29 and 30.

See Section 16 on pages 31 – 35, for programming information. If an error message appears while programming the drive, see Table 6 on page 30.



WARNING! The STOP Key is never to be used as an Emergency Stop or safety disconnect since it is not fail-safe. Use only the AC Line for this purpose.

14.1 START-UP PROCEDURE

After the drive has been properly setup (Jumper J3 set to the corresponding AC Line input voltage being applied to the drive) and wiring completed, the startup procedure can begin. Set the On/Off AC Line Switch to the on position. If the AC power has been properly brought to the drive, the On/Off AC Line Switch will illuminate. To start the drive, press the RUN Key. The motor will begin to accelerate to the Set Frequency. The factory Set Frequency is 05.00 Hz.

Note: *If the motor does not rotate in accordance with the FWD/REV Key, either:*

- 1. Press and hold the FWD/REV Key for 5 seconds to change its operating sense.*
- 2. Use Function 1.01 to change the operating sense of the FWD/REV Key.*
- 3. Reverse any two motor leads (AC Line must be disconnected).*

14.2 KEYPAD DESCRIPTION

The Keypad has eight (8) keys, which are used to program drive functions. The eight (8) LEDs provide indication of the drive's operational status. The built-in potentiometer is used to set the Drive Frequency (Function 2.00 set to "0001").

Note: *To avoid damage, never operate the keypad with a screwdriver or other sharp-ended tool.*

Application Notes: **1.** Adjustment of Set Frequency can be switched between the built-in potentiometer and the keypad using shortcut keys. See Appendix A on page 36. **2.** For applications that require changing motor direction, the sense of the FWD/REV Key can be changed, without requiring reprogramming the drive or reversing any two motor leads. See Appendix B on page 37. **3.** See Appendix C on pages 38 and 39 for resetting the drive to the Factory Setting and OEM Custom Program and to save and recall a User Custom Program.

14.3 FLOW CHARTS FOR IMPORTANT PROGRAMMING FUNCTIONS

See Figures 10 – 17 on pages 23 – 28 for flow charts to program important functions. The flow charts also serve as a guide to understand the programming procedure. See Table 6 on pages 29 and 30 for a description of the Digital Readout codes.

**FIGURE 10
PROGRAMMING MOTOR NAMEPLATE CURRENT***

(Example: Change Motor Nameplate Current from 2.4 Amps to 1.5 Amps)

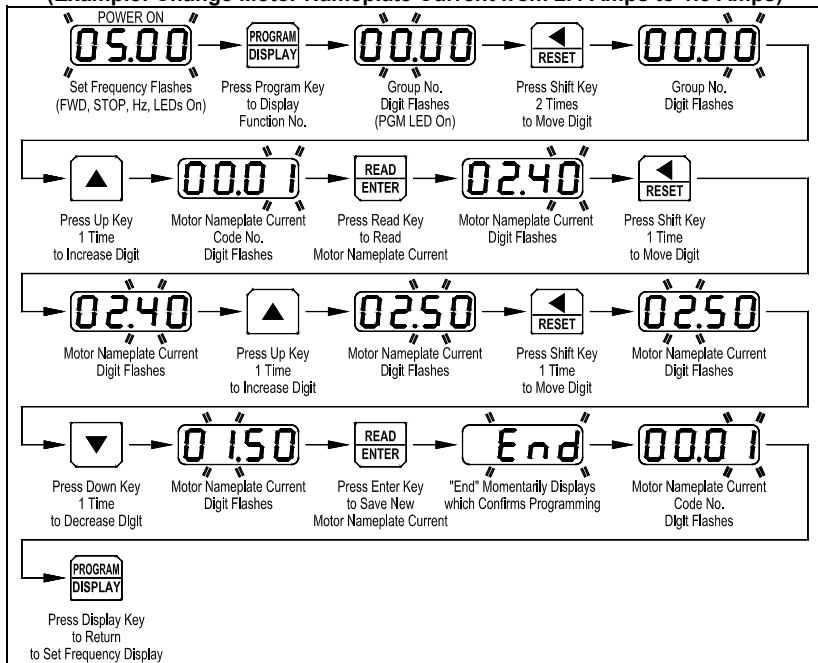

*Drive must be in Stop Mode. Function 0.01.

FIGURE 11
PROGRAMMING SET FREQUENCY*

(Example: Change Set Frequency from 5.00 Hz to 43.21 Hz)

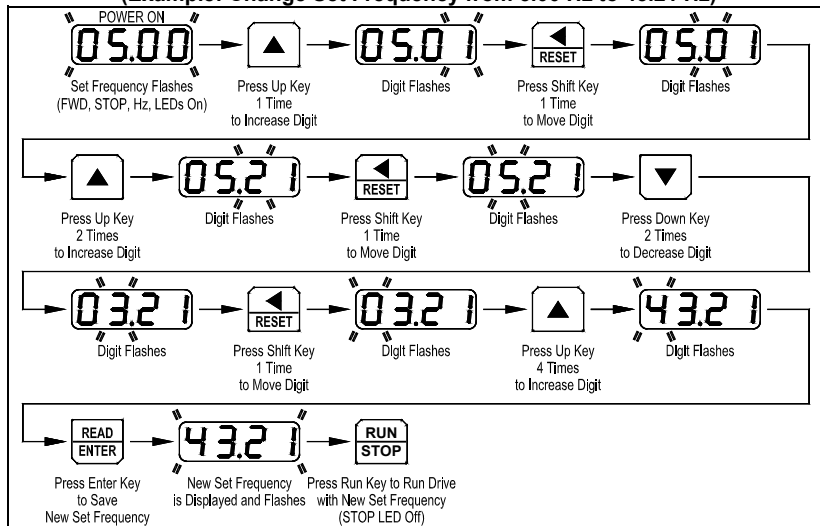

**If Function 2.01 is set to "0000", frequency change requires pressing the ENTER Key. Throughout the sequence, you must proceed to the next step within 20 seconds, before the "Press Enter Key" step, or the display will revert back to "05.00". The new value will be stored in Function 3.00.*

FIGURE 12
PROGRAMMING RATED MOTOR FREQUENCY*

(Example: Change Rated Motor Frequency for 50 Hz Motor)

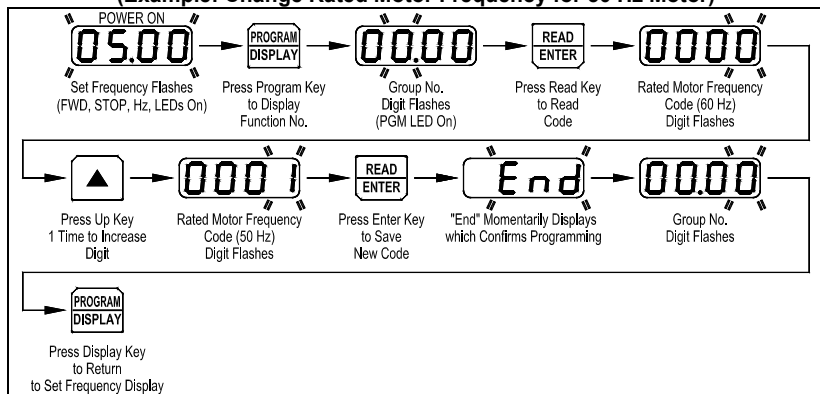

**Drive must be in Stop Mode. Function 0.00.*

**FIGURE 13
PROGRAMMING ACCEL TIME***

(Example: Change Accel Time from 1.5 Seconds to 10.0 Seconds)

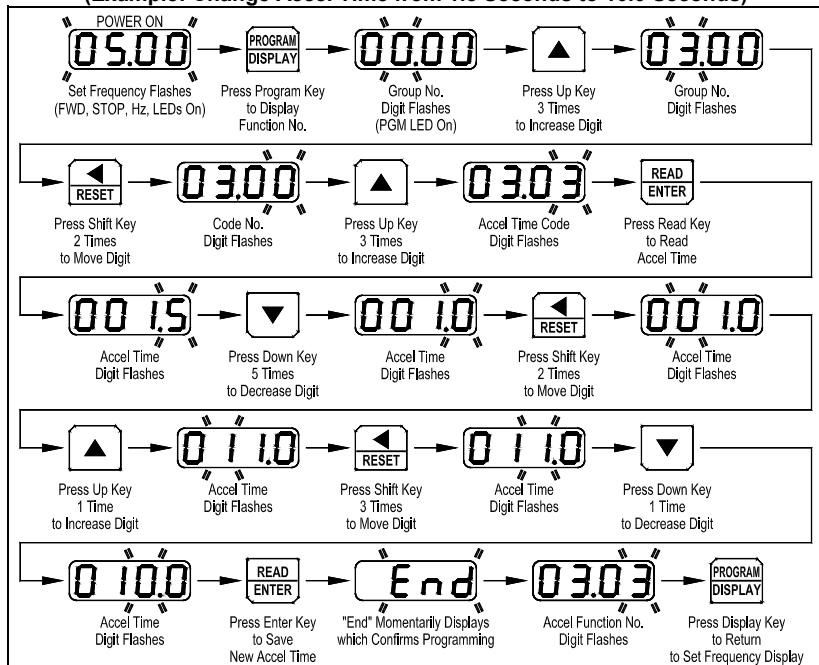

*The factory setting of Accel Time (Function 3.03) is "1.5" seconds. Therefore, the left digits must be changed first since an Accel setting of "000.0" is not allowed.

FIGURE 14
PROGRAMMING DISPLAY FOR CUSTOM UNITS*
(Example: Change Display to Show Custom Units "012.0")

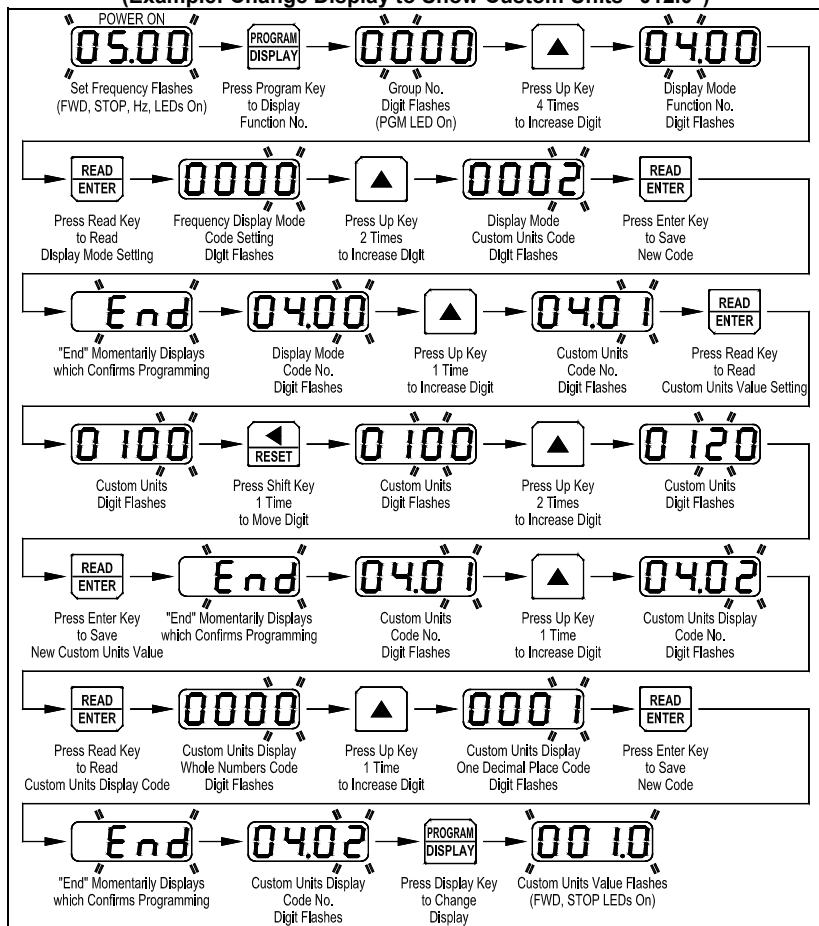

*The factory setting of Display Mode (Function 4.00) is Frequency ("0000"). The factory setting of Custom Units Significant Digits (Function 4.01) is "0100". The factory setting of Custom Units Display (Function 4.02) is Whole Numbers ("0000"). The Custom Units setting "012.0" will be displayed at full speed.

FIGURE 15
PROGRAMMING DISPLAY*

(Example: Change Display from Frequency Display to Motor RPM Display)

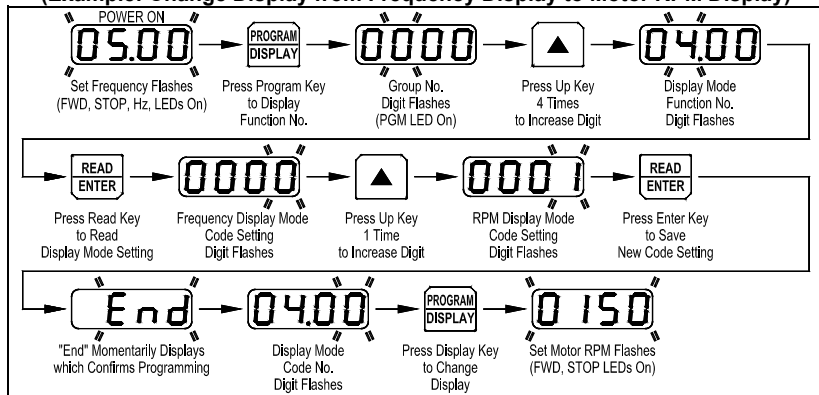

*The factory setting of Display Mode (Function 4.00) is Frequency ("0000").

FIGURE 16
ADDING PARAMETERS TO BASIC DISPLAY*

(Example: Add Motor Current, Motor Voltage, and Bus Voltage to Basic Display)

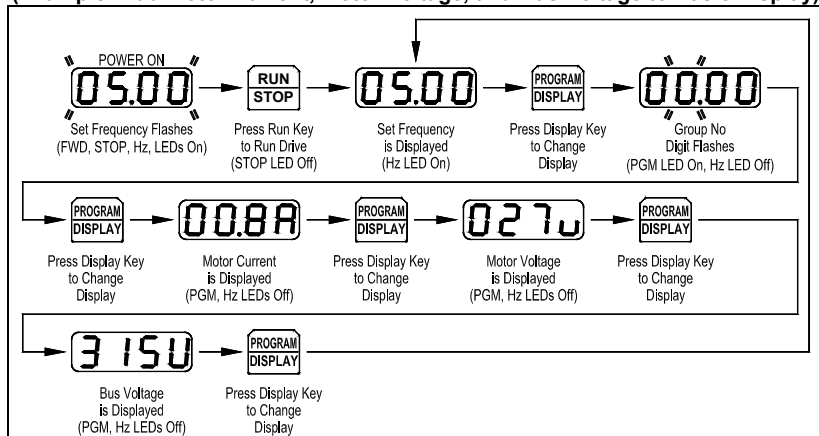

*Functions 4.04, 4.05, and 4.06 set to "0001".

FIGURE 17
PROGRAMMING FUNCTION ACCESS LOCKOUT AND SETTING A PASSCODE*
(Example: Change Passcode from "0000" to "1234")

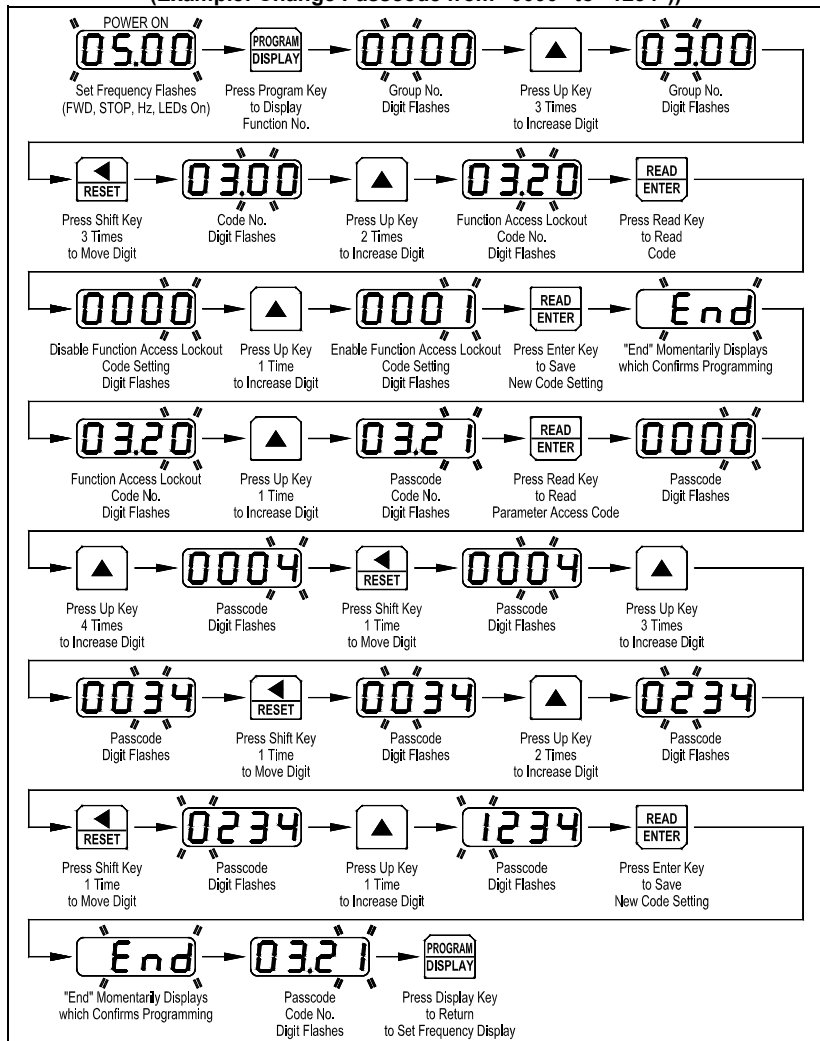

*Function 3.20 set to "0001" and Function 3.21 set to "1234". To reset a forgotten Passcode, set Function 7.10 to "5555".

15 4-DIGIT DISPLAY READOUT CODES

The 4-digit display provides readout of drive status, functions, and faults. See Table 6 for the Digital Readout Codes displayed and their descriptions.

Fault Recovery: The drive monitors many faults. See Function 1.04 for restarting the drive after a fault has been cleared.

Drive Faults: Undervoltage (-LU-), Overvoltage (-OU-), Short Circuit at the motor (phase-to-phase) (-SC-), and I²t or I*t Fault (OL-t).



WARNING! Do not depend on the LEDs or the 4-Digit Display to no longer be illuminated as a guaranteed power off condition. Be sure that the main power switch or circuit breaker is in the "OFF" position before servicing the drive.

TABLE 6
DIGITAL READOUT CODES

Display	Description
STOP	Drive Stopped: Indicates that the drive is in the Stop Mode. Function 4.03 set to "0001".
End	Function Changed: Momentarily flashes. Indicates that a function has been successfully changed.
0301	Function No.: Consists of a Group No. (digits on left side of decimal point) and a Group Code No. (digits on right side of decimal point).
--.A	Motor Current Display: When the display is set to show Motor Current, the format will be "XX.XA". Function 4.04 set to "0001".
---U	Motor Voltage Display: When the display is set to show Motor Voltage, the format will be "XXXu". Function 4.05 set to "0001".
---U	Bus Voltage Display: When the display is set to show Bus Voltage, the format will be "XXXU". Function 4.06 set to "0001".
-LU-	Low Voltage Trip: Indicates that the AC line input voltage is below the Undervoltage Trip Point specified in Table 3 on page 9.
LU-r	Low Voltage Recovery: Indicates that a Low Voltage Trip occurred and the AC line input voltage returned to within the operating range specified in Table 3 on page 9.
-OU-	Overvoltage Trip: Indicates that the AC line input voltage is above the Overvoltage Trip Point specified in Table 3 on page 9.
OU-r	Overvoltage Recovery: Indicates that an Overvoltage Trip occurred and the AC line input voltage returned to within the operating range specified in Table 3 on page 9.
OL-t	Overload Trip (I²t Timeout): Indicates that the motor has been overloaded for an extended period of time.

Table 6 continued on next page...

TABLE 6
DIGITAL READOUT CODES (CONTINUED)

Display	Description
-SC-	Short Circuit Fault: Indicates that the drive detected a short circuit at the motor (phase-to-phase).
Err	Data Enter Error: Indicates that the drive is in the Program Mode and a non-valid function change has been attempted.
ErrS	Key Error: The UP and Down Keys are disabled for editing the frequency or the FWD/REV Key is disabled for changing direction.
EE-1	On-Board Memory Error: * The On-Board Memory on the drive is not detected.
EE-5	Checksum Error: * The program selected is corrupt.
EE-6	Program Location Blank Error: * The program location selected does not contain any data.
LoC	Passcode Lock: Indicates that functions have been passcode locked.
PA d	Keypad: Momentarily displayed when the shortcut feature is used to change the source for adjusting Set Frequency to use the Keypad. See Appendix A on page 36.
Pot	Built-In Potentiometer: Momentarily displayed when the shortcut feature is used to change the source for adjusting Set Frequency to use the Built-In Potentiometer. See Appendix A on page 36.
F-C0	Momentarily displayed when the shortcut feature is used to change the sense of the FWD/REV Key. See Appendix B on page 37.
F-C	Momentarily displayed when the shortcut feature is used to change the sense of the FWD/REV Key back to the factory setting. See Appendix B on page 37.
CP-1	Copy Program Operation 1: Momentarily displayed when the shortcut feature is used to recall a saved User Custom Program to the Active Memory. See Appendix C on pages 38 and 39.
CP-2	Copy Program Operation 2: Momentarily displayed when the shortcut feature is used to save a User Custom Program. See Appendix C on pages 38 and 39.

**If error "EE-1", "EE-5", or "EE-6" is displayed, press the Reset Key to clear it. All drive functions will be reset. If the error persists, contact our Sales Department.*

16 PROGRAMMABLE FUNCTIONS LIST

All functions have been factory set, as shown in the tables on pages 32 – 35. The *Detailed Programmable Function List* is available – contact our Sales Department. The drive contains a memory location, which can be used to store a User Custom Program, as described in Appendix C on pages 38 and 39.

Programming Mode: When the drive is put into the Programming Mode, a Function No. will be displayed. A Function No. consists of a Group No. (digits on left side of decimal point) and a Group No. Code (digits on right side of decimal point). The digits can be changed using the Up and Down Keys. The Left Shift Key is used to move the changeable digit. When the READ Key is pressed, either a Code or Value will be displayed. Codes have specific descriptions. Values have numeric ranges. See Figure 18.

Application Note: The programming of the drive can be performed without a motor connected.

FIGURE 18
FUNCTION NO. DESCRIPTION

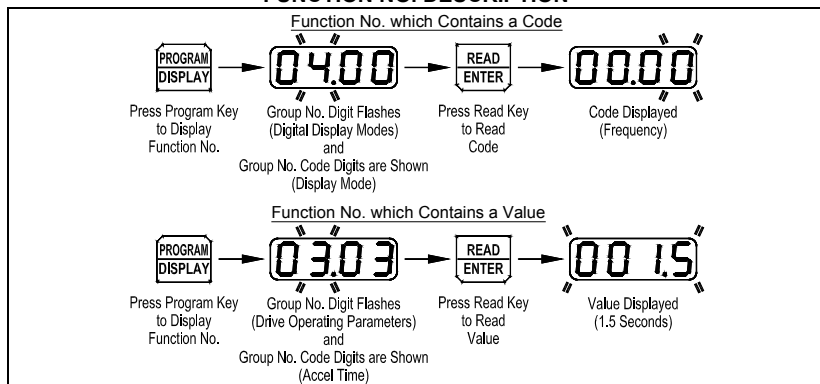

Programmable Function Groups

Function Group No.	Description
0	Motor and Drive Parameters
1	Run/Stop Mode
2	Frequency Control
3	Drive Operating Parameters
4	Digital Display Modes
5	Drive Status and Reset

FUNCTION GROUP 0: Motor and Drive Parameters

Function No.	Description	Range/Code	Factory Setting	User Setting
0.00 *	Rated Motor Frequency (Hz)	0000: 60 Hz 0001: 50 Hz 0002: Special (Set by 0.05)	0000	
0.01 *	Motor Nameplate Current (Amps)	0 – 2.88	2.40 ⁽¹⁾	
0.02 *	Reserved	—	—	
0.03 *	Torque Mode	0000: Constant Torque (Machinery) 0001: Variable Torque (HVAC)	0000	
0.04 *	GFCI Operation ⁽²⁾	0000: GFCI Operation Disabled 0001: Operation with Standard GFCI 0002: Operation with Sensitive GFCI	0000	
0.05 *	Motor Nameplate Frequency (Hz) ^(3, 4)	30 – 240	60, 50	
0.06 *	Motor Nameplate Voltage (% Drive Output) ⁽⁵⁾	0 – 100	100 ⁽⁶⁾	

Notes: **(1)** Factory Setting is the drive rated output current. This function is used to enter the Motor Nameplate Rated Current, which allows proper operation of the I²t Motor Overload Protection. **(2)** GFCI operation overrides the Switching Frequency set by Function 3.17. **(3)** When the drive is set for 50 Hz motors (Function 0.00 set to "0001"), the Motor Frequency factory setting will automatically reset to 50 Hz. **(4)** The Motor Frequency for standard 50 Hz or 60 Hz motors is set by Function 0.00. For custom motors (e.g., 100 Hz) set Function 0.00 to "0002" and Function 0.05 to the Motor Nameplate Frequency. **(5)** This function is used for motors with non-standard nameplate rated voltage (e.g., 80 Volts AC). **(6)** The factory set output of the drive is 100% of the AC line input voltage. In 60 Hz Mode (Function 0.00 set to "0000") the drive output will be 230 Volts, maximum, for 230 Volt motors. In 50 Hz Mode (Function 0.00 set to "0001") the drive output will be 220 Volts, maximum, for 220 Volt motors.

*Functions which can only be changed while the drive is in the Stop Mode.

FUNCTION GROUP 1: Run/Stop Mode

Function No.	Description	Range/Code	Factory Setting	User Setting
1.00 *	Forward/Reverse Control	0000: Instant Reverse 0001: Stop Command Must be Given Prior to Reverse Command 0002: Reverse Command Disabled 0003: Forward Command Disabled	0000	
1.01 *	Motor Direction ⁽¹⁾	0000: Forward 0001: Reverse	0000	
1.02 *	Start Command	0000: Accelerates to Last Set Frequency 0001: Accelerates to Lower Frequency Limit (See 3.01)	0000	
1.03 *	Restart Mode	0000: Spin Start 0001: Stop before Restart	0000	
1.04 *	Auto/Manual Start Mode	0000: Manual Start 0001: Manual Start with Ride-Through (Set by 1.05) 0002: Auto Start After Undervoltage Fault Clears 0003: Auto Start All Faults (Except I ² t, I*t, and Short Circuit Faults) 0004: Auto Start All Faults (Except Short Circuit Fault) ⁽²⁾	0000	
1.05 *	Ride-Through Time (Seconds)	0.0 – 2.0	0.5	
1.06 *	Number of Restart Attempts	0 – 10	3	
1.07 *	Start Delay Time (Seconds)	0 – 240	0	
1.08 *	Stop Mode	0000: Regenerate-to-Stop 0001: Coast-to-Stop 0002: Regeneration with DC Injection Brake-to-Stop (Set by 1.10, 1.11, 1.12)	0000	
1.09 *	Holding Torque in Stop Mode (%)	0 – 10	0	
1.10	Injection Brake Start Frequency (Hz)	0.00 – 240.0	0.00	
1.11	Injection Brake Level (%)	0 – 30	0	
1.12	Injection Brake Time (Seconds)	0.0 – 25.5	0.0	

Notes: (1) For applications that require changing motor direction, the sense of the FWD/REV Key can also be changed without requiring reprogramming the drive or reversing any two motor leads. Press and hold the FWD/REV Key for 5 seconds. The forward direction will now be "reverse" and the reverse direction will now be "forward". (2) For Auto Start, Function 1.06 must be set to greater than "0" (factory setting is "3").

*Functions which can only be changed while the drive is in the Stop Mode.

FUNCTION GROUP 2: Frequency Control

Function No.	Description	Range/Code	Factory Setting	User Setting
2.00 *	Frequency Control	0000: Keypad 0001: Built-In Potentiometer	0000	
2.01 *	Up Key, Down Key Operation Mode	0000: Frequency Change Requires Enter Command 0001: Direct Frequency Change 0002: Keypad Disable	0000	
2.02 *	Jog Key	0000: Jog Key Enabled (Momentary) 0001: Jog Key Enabled (Latching) 0002: Jog Disabled	0000	

Note: (1) Adjustment of Set Frequency can be switched between the built-in potentiometer and the keypad. See Appendix A on page 36.

*Functions which can only be changed while the drive is in the Stop Mode.

FUNCTION GROUP 3: Drive Operating Parameters

Function No.	Description	Range/Code	Factory Setting	User Setting
3.00	Stored Set Frequency (Hz)	0.00 – 240.0	5.00	
3.01	Lower Frequency Limit (Hz)	0.00 – 240.0	0.00	
3.02	Upper Frequency Limit (Hz) ⁽¹⁾	0.00 – 240.0	60.0, 50.0	
3.03	Accel Time (Seconds) ⁽²⁾	0.1 – 180.0	1.5	
3.04	Decel Time (Seconds) ⁽²⁾	0.3 – 180.0	1.5	
3.05	S-Curve Time Accel (Seconds) ⁽²⁾	0.0 – 30.0	0.0	
3.06	S-Curve Time Decel (Seconds) ⁽²⁾	0.0 – 30.0	0.0	
3.07 *	Skip Frequency (Hz)	0.00 – 240.0	0.00	
3.08 *	Skip Frequency Bandwidth (\pm Hz)	0.00 – 2.00	0.00	
3.09 *	Motor Overload Protection	0000: I ² t with Current Limit (CL is 160% of Function 0.01) 0001: I*t with Current Limit (CL is 120% of Function 0.01)	0000	
3.10 *	I*t with Current Limit Trip Time (Seconds)	1.0 – 20.0	6.0	
3.11	Reserved	—	—	
3.12	Reserved	—	—	
3.13	Jog Frequency	0.00 – 240.0	10.00	
3.14	Jog Accel/Decel Time (Seconds)	0.3 – 180.0	1.0	
3.15	Boost Mode	0000: Auto 0001: Fixed (See 3.16)	0000	
3.16	Boost Value (%)	0.0 – 28.0	7.0	
3.17 *	Switching Frequency (kHz)	0000: 8 0001: 10 0002: 12	0000	
3.18	Flux Vector Compensation (%)	0.0 – 10.0	5.0	
3.19	Reserved	—	—	
3.20	Function Access Lockout	0000: Disable 0001: Enable	0000	
3.21	Passcode ⁽³⁾	0 – 9999	0000	
3.22–3.25	Reserved	—	—	

Notes: (1) When the drive is set for 50 Hz motors (Function 0.00 set to "0001"), the Upper Frequency Limit factory setting will automatically reset to 50 Hz. **(2)** Time set for Functions 3.03 and 3.04 must be equal to or greater than the time set for Functions 3.05 and 3.06, respectively. **(3)** To reset a forgotten Passcode, set Function 7.10 to "5555".

*Functions which can only be changed while the drive is in the Stop Mode.

FUNCTION GROUP 4: Digital Display Modes

Function No.	Description	Range/Code	Factory Setting	User Setting
4.00	Display Mode	0000: Frequency 0001: RPM ⁽¹⁾ 0002: Custom Units (Default is "0100")	0000	
4.01	Custom Units (Significant Digits)	0 – 9999	100	
4.02	Custom Units Display	0000: Whole Numbers (XXXX) 0001: 1 Decimal Place (XXX.X) 0002: 2 Decimal Places (XX.XX) 0003: 3 Decimal Places (X.XXX)	0000	
4.03	Display in Stop Mode	0000: Displays Last Run Setting 0001: Displays "Stop" 0002: Displays "0000"	0000	
4.04	Motor Current Display ^{(2), (3)}	0000: Disabled 0001: Enabled	0000	
4.05	Motor Voltage Display ^{(2), (3)}	0000: Disabled 0001: Enabled	0000	
4.06	Bus Voltage Display ^{(2), (3)}	0000: Disabled 0001: Enabled	0000	
4.07–4.10	Reserved	—	—	

Notes: (1) Based on 4-pole motor. (2) The Display Key is used to toggle between displays. (3) If Motor Current Display is enabled, the display will show "XX.XA". If Motor Voltage Display is enabled, the display will show "XXXu". If Bus Voltage Display is enabled, the display will show "XXXU".

FUNCTION GROUP 5: Drive Status and Reset

Function No.	Description	Range/Code	Factory Setting	User Setting
5.00 *	Drive ID	—	—	
5.01 *	Software Version	—	—	
5.02 *	Drive Horsepower	—	—	
5.03 *	Fault Log 1	—	—	
5.04 *	Fault Log 2	—	—	
5.05 *	Fault Log 3	—	—	
5.06 **	Reset Drive	1111: Factory Settings 1010: OEM Custom Program 1100: User Custom Program	0000	
5.07–5.10	Reserved	—	—	

*Read only.

**Functions which can only be changed while the drive is in the Stop Mode.

APPENDIX A

KEYPAD/POTENTIOMETER SET FREQUENCY SELECT (SHORTCUT)

The Keypad/Potentiometer shortcut allows the selection of the source for adjusting the Set Frequency without requiring reprogramming the drive. The Keypad is factory programmed as the default for adjusting the Set Frequency.

TO USE THE BUILT-IN POTENTIOMETER TO ADJUST SET FREQUENCY

Press both Up and Down Keys  simultaneously for 4 seconds.

Pot will be momentarily displayed.

The Set frequency can now be adjusted using the built-in Potentiometer.

TO SWITCH BACK TO USING THE KEYPAD TO ADJUST SET FREQUENCY

Press both Up and Down Keys  simultaneously for 4 seconds.

PRd will be momentarily displayed.

The Set Frequency can now be adjusted using the Keypad.

APPENDIX B

CHANGING OPERATING SENSE OF THE FWD/REV KEY (SHORTCUT)

For applications that require changing motor direction, the FWD/REV shortcut allows changing the sense of the FWD/REV Key without requiring reprogramming the drive or reversing any two motor leads.

TO CHANGE THE SENSE OF THE FWD/REV KEY*

Press and hold the FWD/REV Key  for 5 seconds.

 will be momentarily displayed.

**Be sure the drive is in the Stop Mode.*

TO RETURN TO THE FACTORY SETTING OF THE FWD/REV KEY*

Press and hold the FWD/REV Key  for 5 seconds.

 will be momentarily displayed.

**Be sure the drive is in the Stop Mode.*

APPENDIX C

RESET AND MEMORY FUNCTIONS

The drive contains three memory locations, as described below. See page 39 for the procedures to save and recall a User Custom Program using shortcut keys.

FACTORY SETTINGS

Contains the original factory settings for 60 Hz motor operation. Set Function 5.06 to "1111" to reset the drive to factory settings.

Note: This automatically sets Function 0.00 (Rated Motor Frequency) to "0000" (60 Hz). For 50 Hz motors, set Function 0.00 to "0001".

OEM CUSTOM PROGRAM

Contains a custom program that is factory installed for a specific OEM application. Set Function 5.06 to "1010" to activate this program.

Note: Unless the drive has been specifically programmed for a custom OEM application, the default program is the same as the original factory program.

USER CUSTOM PROGRAM

When program changes are made by the user, these changes are stored in the Active Memory location. These changes do not have to be stored and will remain in the Active Memory unless additional changes are made. The user can store the **First Set of Changes** prior to making the **Second Set of Changes** by setting Function 5.06 to "1100". See example below in Table 7.

Typically, this feature would be used if the drive has been programmed for a particular application and the user has another application for which some of the parameters need to be changed but desires to retain the original settings.

TABLE 7
EXAMPLE OF USER CUSTOM PROGRAM CHANGES

Function No.	Description	Factory Setting	First Set of Changes (Function 5.06 Set to "1100")	Second Set of Changes (In Active Memory)
0.01	Motor Nameplate Current (Amps)	2.40	2.00	1.80
1.04	Auto/Manual Start Mode	0000 Manual Start	0002 Auto Start After Undervoltage Fault Clears	0003 Auto Start All Faults
3.03	Accel Time (Seconds)	1.5	5.0	10.0

PROCEDURES TO SAVE AND RECALL A USER CUSTOM PROGRAM

TO SAVE A USER CUSTOM PROGRAM*

Using the READ/ENTER Key as a Shortcut Key

Press and hold the READ/ENTER Key  for 4 seconds.

 will be momentarily displayed.

The program is now saved to the User Custom Program memory location.

**Be sure the drive is in the Stop Mode and not in the Program Mode.*

TO RECALL A SAVED USER CUSTOM PROGRAM TO THE ACTIVE MEMORY*

Using the PROGRAM/DISPLAY Key as a Shortcut Key

Press and hold the PROGRAM/DISPLAY Key  for 2 seconds.

 will be momentarily displayed.

The saved User Custom Program is now recalled to the Active Memory.

**Be sure the drive is in the Stop Mode and not in the Program Mode.*

Using Function 5.06

Set Function 5.06 to "1100".

 will be momentarily displayed.

The saved User Custom Program is now recalled to the Active Memory.

**Be sure the drive is in the Stop Mode.*

APPENDIX D

FUNCTION ACCESS LOCKOUT AND PASSCODE

The drive contains a programmable passcode feature, which can be used to prevent tampering or unauthorized changes to programmed functions and settings. See Functions 3.20 and 3.21. See Figure 17 on page 28 for enabling the Function Access Lockout feature and an example of setting the passcode to "1234".

Note: To reset a forgotten passcode, set Function 7.10 to "5555".

LIMITED WARRANTY

For a period of 18 months from the date of original purchase, KB Electronics, Inc. will repair or replace without charge, devices which our examination proves to be defective in material or workmanship. This warranty is valid if the unit has not been tampered with by unauthorized persons, misused, abused, or improperly installed, and has been used in accordance with the instructions and/or ratings supplied. The foregoing is in lieu of any other warranty or guarantee, expressed or implied. KB Electronics, Inc. is not responsible for any expense, including installation and removal, inconvenience, or consequential damage, including injury to any person, caused by items of our manufacture or sale. Some states do not allow certain exclusions or limitations found in this warranty and therefore they may not apply to you. In any event, the total liability of KB Electronics, Inc., under any circumstance, shall not exceed the full purchase price of this product. (rev. 2/2002)

COPYRIGHT © 2014 KB Electronics, Inc.

All rights reserved. In accordance with the United States Copyright Act of 1976, no part of this publication may be reproduced in any form or by any means without permission in writing from KB Electronics, Inc. (8/2002)

**The information contained in this manual is intended to be accurate.
However, the manufacturer retains the right to make changes in design,
which may not be included herein.**



KB Electronics, Inc.

12095 NW 39 Street, Coral Springs, FL 33065-2516

Phone: 954-346-4900; Fax: 954-346-3377

Outside Florida call Toll Free: 800-221-6570

E-Mail: info@kbelectronics.com

www.kbelectronics.com